

PLANTA PRIMER NIVEL-DIAGNOSTICO Y TRATAMIENTO
ESC.1/50

CUADRO DE VANOS DE VENTANAS

VENT.	CDT	ANCHO	ALTO	ALF.	DESCRIPCIÓN
V-7	03	0.50	3.40	1.50	Ventana tipo sistema vidrio templado INCOLORO 6mm
V-8	01	0.80	3.40	1.50	Ventana tipo sistema vidrio templado INCOLORO 6mm
V-9	01	1.40	3.40	0.90	
V-10	01	1.35	3.40	0.90	
V-11	01	0.98	3.40	1.50	
V-12	01	0.81	3.40	0.90	
V-13	01	0.71	3.40	0.90	
V-14	01	0.62	3.40	0.90	
V-15	01	0.61	3.40	0.90	
V-16	01	0.64	3.40	0.90	
V-17	01	2.88	3.40	0.90	
V-18	01	2.00	3.40	0.90	
V-19	01	0.50	2.70	1.50	
V-20	04	0.80	2.70	0.90	
V-21	02	0.90	2.70	0.90	
V-22	01	4.00	3.60	3.20	

CUADRO DE VANOS DE PUERTAS

VENT.	CDT	ANCHO	ALTO	ALF.	DESCRIPCIÓN
P-10	01	1.40	2.40	--	Puerta contrapicada con MDF 9mm
P-11	11	1.20	2.10	--	Puerta contrapicada con MDF 9mm
P-12	03	1.20	2.40	--	Puerta contrapicada con MDF 9mm
P-13	06	0.80	2.10	--	Puerta contrapicada con MDF 9mm
P-14	01	1.00	2.10	--	Puerta contrapicada con MDF 9mm
P-15	07	0.90	2.10	--	Puerta contrapicada con MDF 9mm

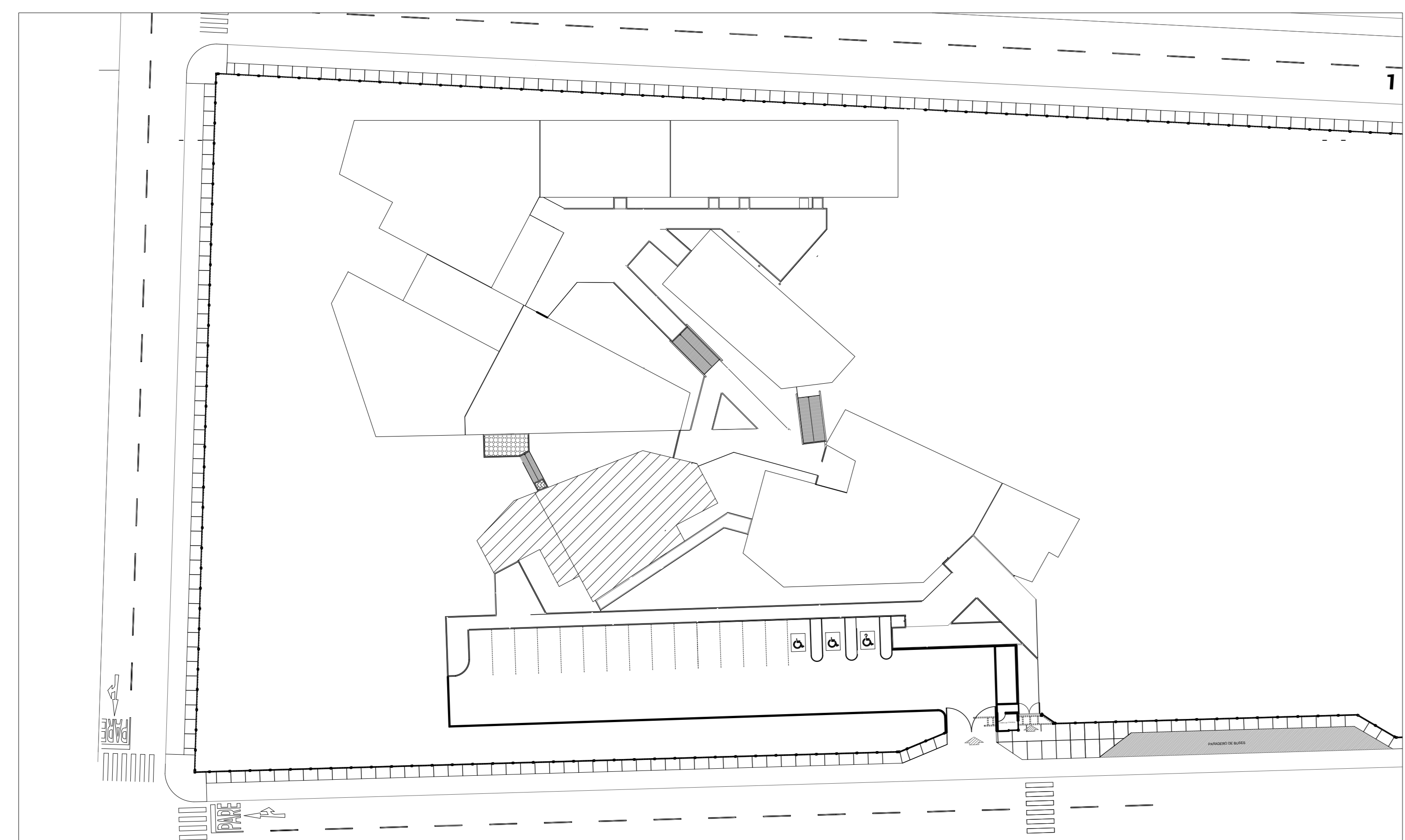

PLANO DE REFERENCIA

CUADRO DE ACABADOS

CUADRO DE ACABADOS

ZONA	ACABADOS											
	PARTIDAS	PISOS	MUROS Y COLUMNAS	ZOCALO	CONTRAZOCALO	C./RASO-F.C.R.	CARPINTERIA	PINTURA	APARATOS	SANITA	BRIFERIAS	ACCESORIOS
PRIMER NIVEL												
DIAGNOSTICO Y TRATAMIENTO												

UNIVERSIDAD PRIVADA DE TACNA
FACULTAD DE ARQUITECTURA Y URBANISMO

CENTRO DE ATENCIÓN INTEGRAL DE TERAPIA PARA EL ADULTO MAYOR CON DISCAPACIDAD FÍSICA MOTORA EN EL DEPARTAMENTO DE TACNA-2017

V TALLER TUTORIAL DE TESIS

PLANO: MODULO DE PROYECTO

ASISOR: ARQ. EDGAR MIGUEL HINOJOSA VEGA
FECHA: MARZO 2018

TESISTA: BACH. ARQ. ROYDAN FRANCO NOA

Nº de LÁMINA: A-05

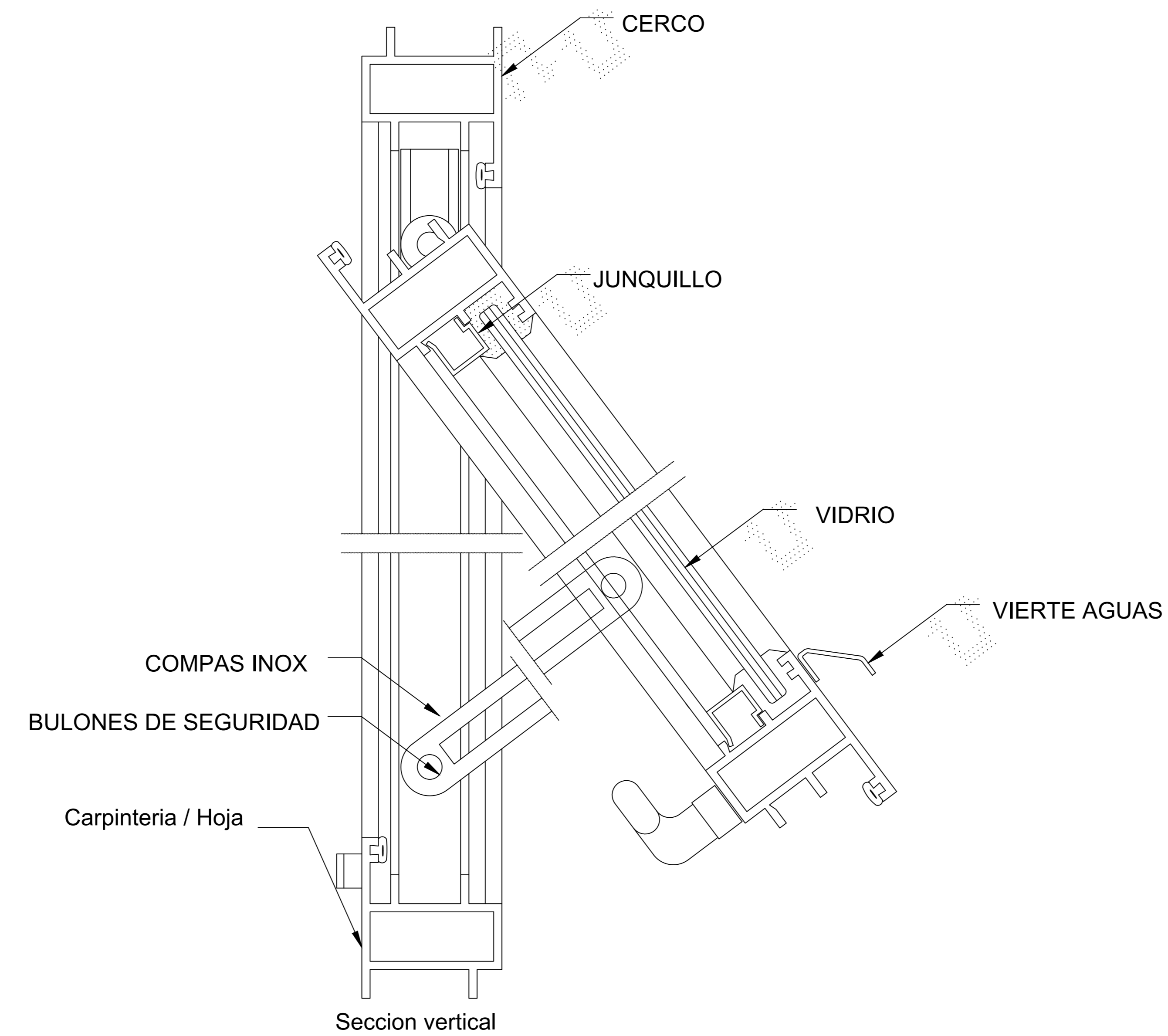

DETALLE 01
ESC.1/5

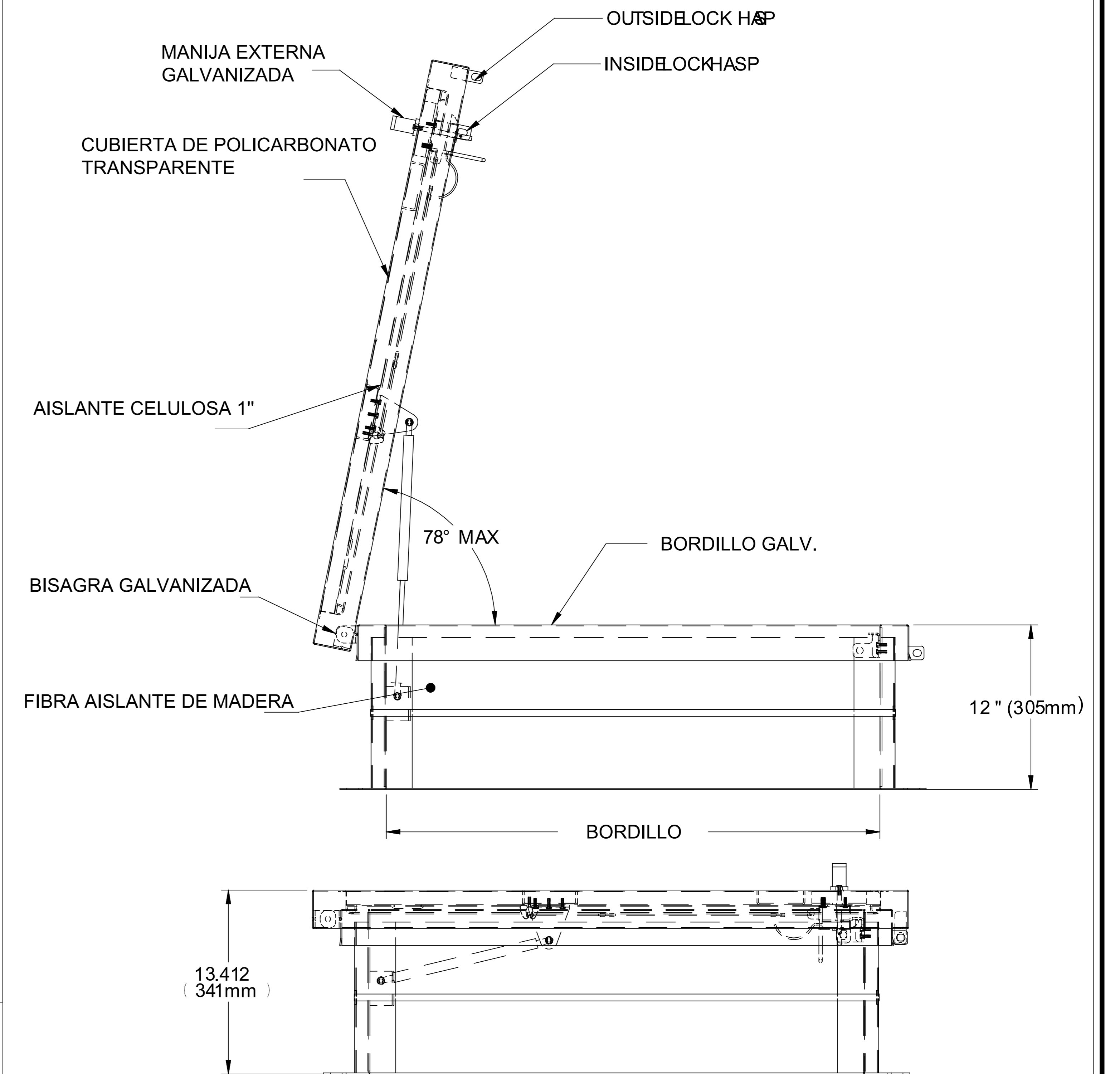

DETALLE 02
ESC.1/5

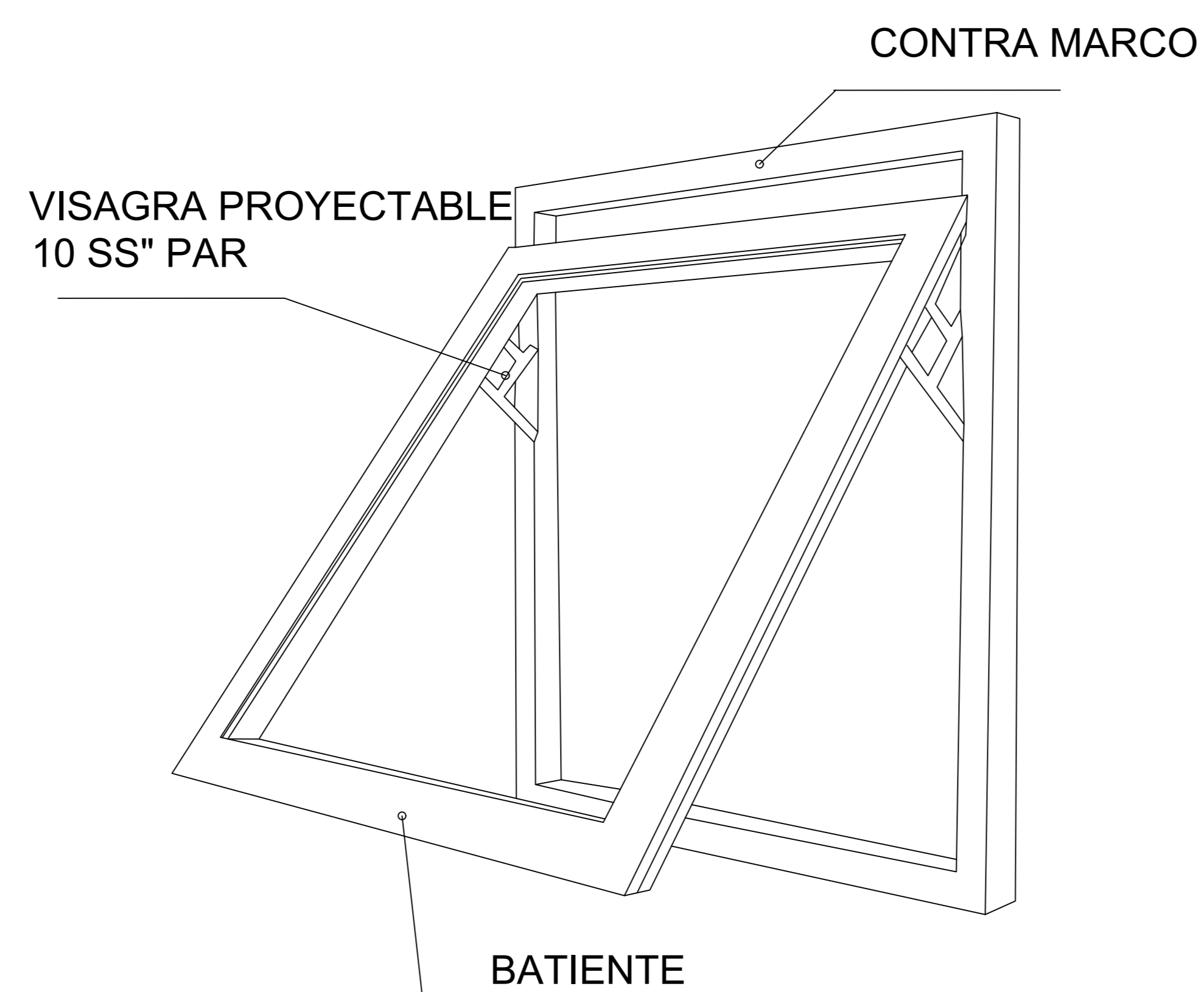

ISOMETRICO DE VENTANA BATIENTE

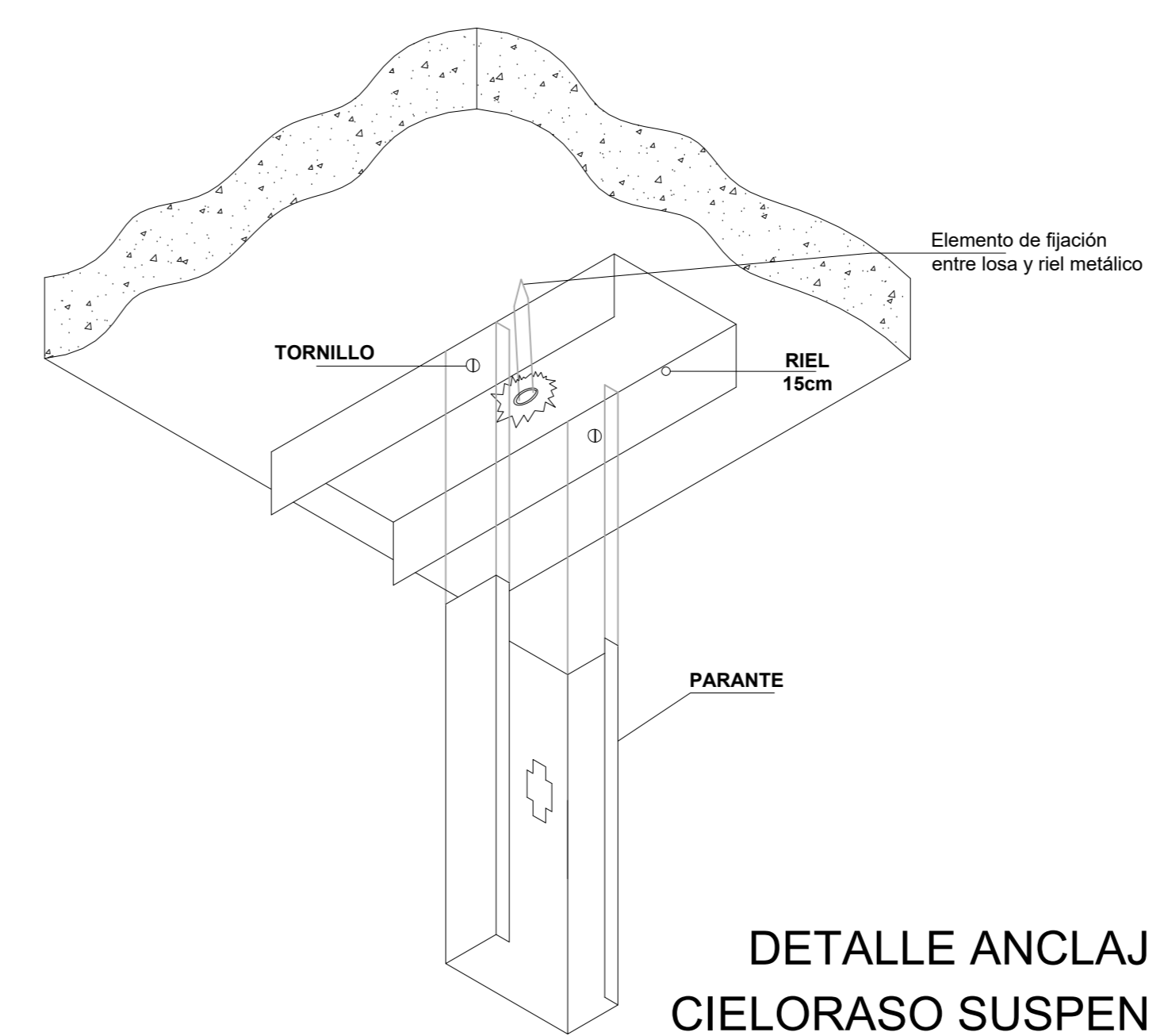

DETALLE ANCLAJE CIELORASO SUSPENDIDO



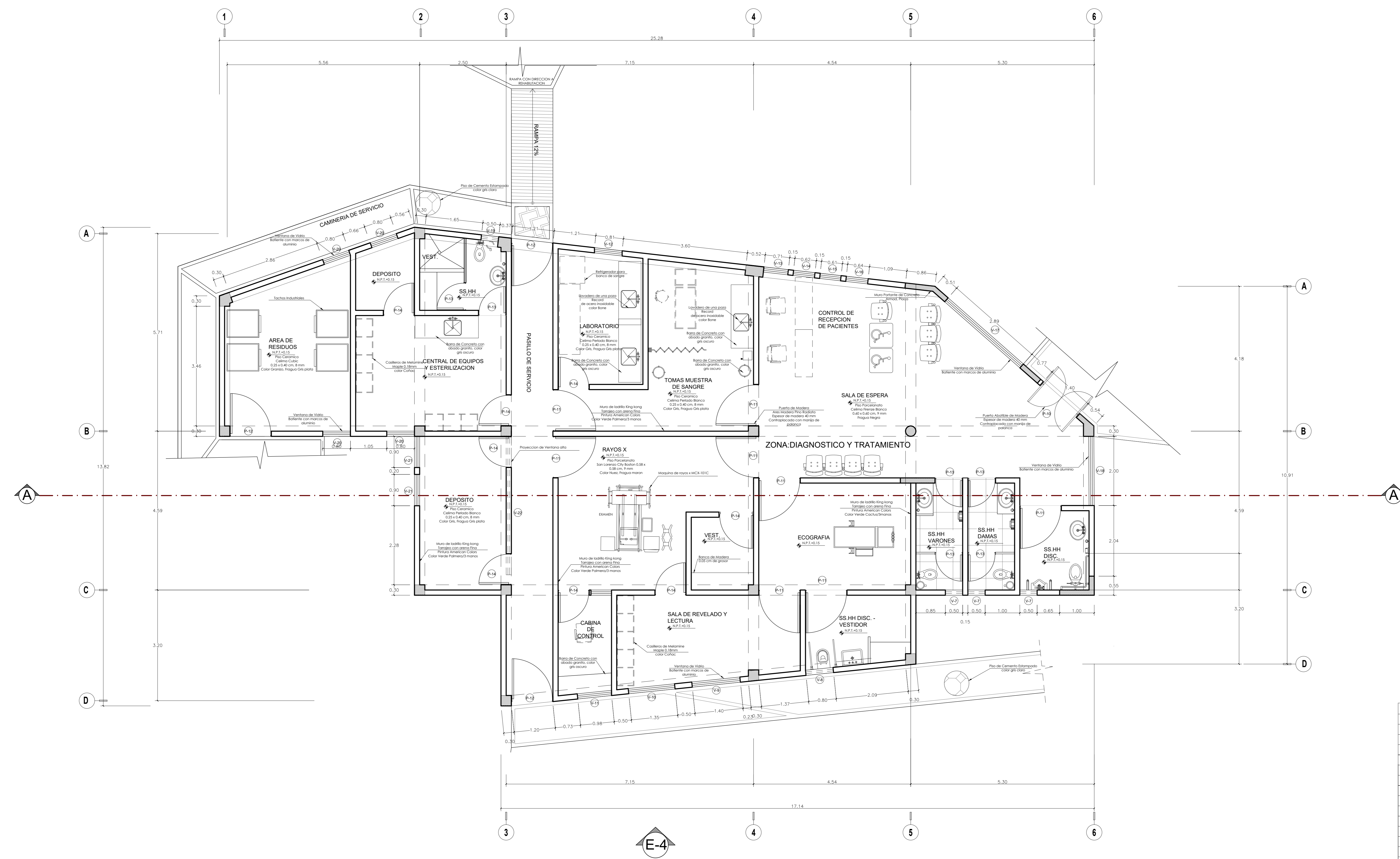
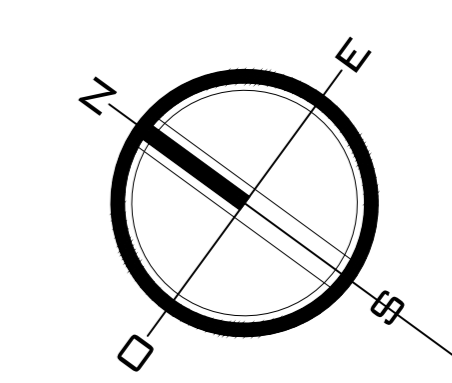

PLANTA PRIMER NIVEL-DIAGNOSTICO Y TRATAMIENTO
ESC. 1/50

CUADRO DE VANOS DE VENTANAS

VENT.	CDT	ANCHO	ALTO	ALF.	DESCRIPCIÓN
V-7	03	0.50	3.40	1.50	Ventana tipo sistema vidrio templado INCOLORO 6mm
V-8	01	0.80	3.40	1.50	Ventana tipo sistema vidrio templado INCOLORO 6mm
V-9	01	1.40	3.40	0.90	
V-10	01	1.35	3.40	0.90	
V-11	01	0.98	3.40	1.50	
V-12	01	0.81	3.40	0.90	
V-13	01	0.71	3.40	0.90	
V-14	01	0.62	3.40	0.90	
V-15	01	0.61	3.40	0.90	
V-16	01	0.64	3.40	0.90	
V-17	01	2.88	3.40	0.90	
V-18	01	2.00	3.40	0.90	
V-19	01	0.50	2.70	1.50	
V-20	04	0.80	2.70	0.90	
V-21	02	0.90	2.70	0.90	
V-22	01	4.00	3.60	3.20	

CUADRO DE VANOS DE PUERTAS

VENT.	CDT	ANCHO	ALTO	ALF.	DESCRIPCIÓN
P-10	01	1.40	2.40	--	Puerta contrapicada con MDF 9mm
P-11	11	1.20	2.10	--	Puerta contrapicada con MDF 9mm
P-12	03	1.20	2.40	--	Puerta contrapicada con MDF 9mm
P-13	06	0.80	2.10	--	Puerta contrapicada con MDF 9mm
P-14	01	1.00	2.10	--	Puerta contrapicada con MDF 9mm
P-15	07	0.90	2.10	--	Puerta contrapicada con MDF 9mm

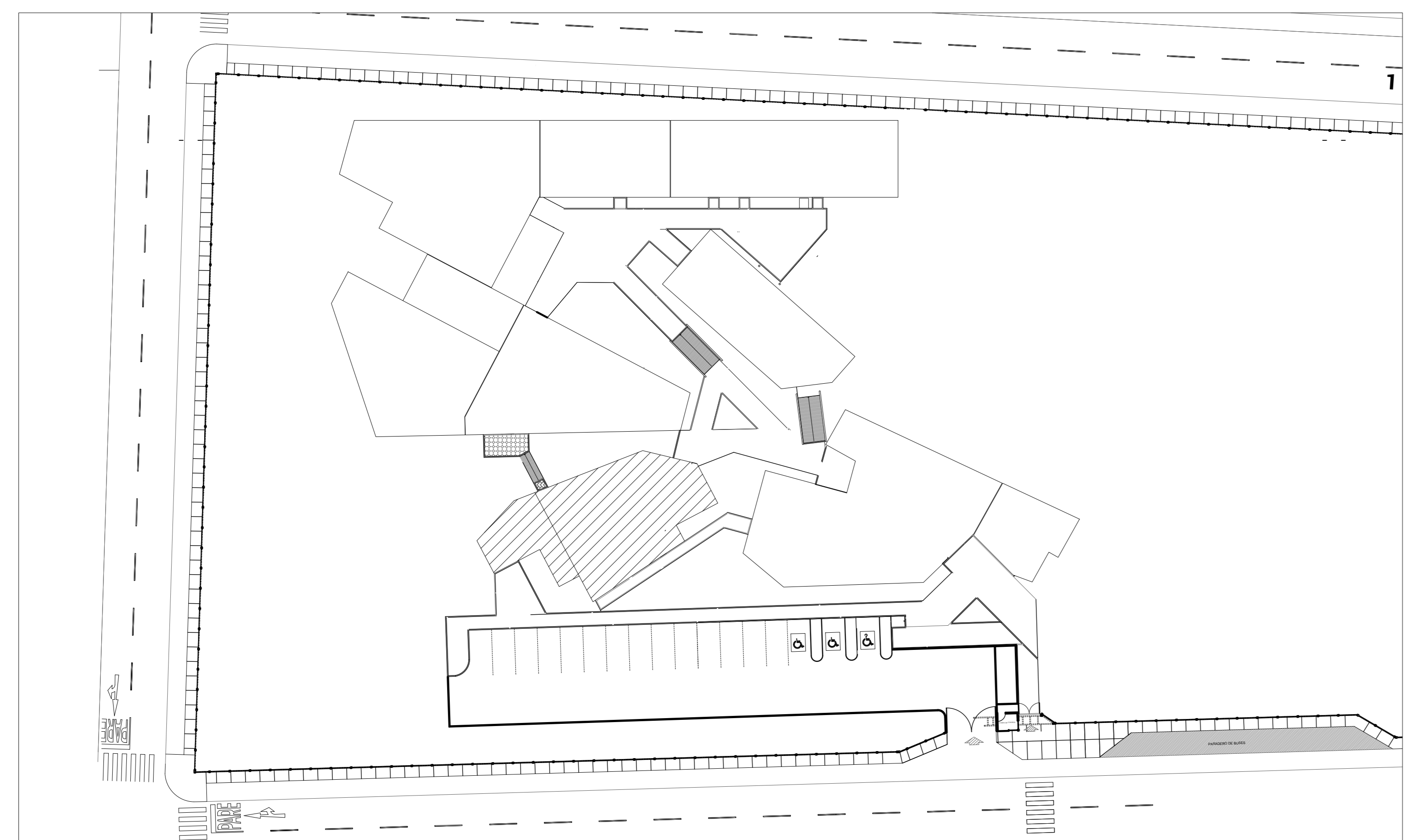

PLANO DE REFERENCIA

CUADRO DE ACABADOS

CUADRO DE ACABADOS

ZONA	ACABADOS												
	PARTIDAS	PISOS	MUROS Y COLUMNAS	ZOCALO	CONTRAZOCALO	C./RASO-F.C.R.	CARPINTERIA	PIRATA	CRISTALES	APARATOS	SANITA	BRIFERIAS	ACCESORIOS
PRIMER NIVEL													
DIAGNOSTICO Y TRATAMIENTO													

UNIVERSIDAD PRIVADA DE TACNA
FACULTAD DE ARQUITECTURA Y URBANISMO

CENTRO DE ATENCIÓN INTEGRAL DE TERAPIA PARA EL ADULTO MAYOR CON DISCAPACIDAD FÍSICA MOTORA EN EL DEPARTAMENTO DE TACNA-2017

V TALLER TUTORIAL DE TESIS

PLANO: MODULO DE PROYECTO

ASesor: ARQ. EDGAR MIGUEL HINOJOSA VEGA
FECHA: MARZO 2018

TESISTA: BACH. ARQ. ROYDAN FRANCO NOA

Nº de LÁMINA: A-05

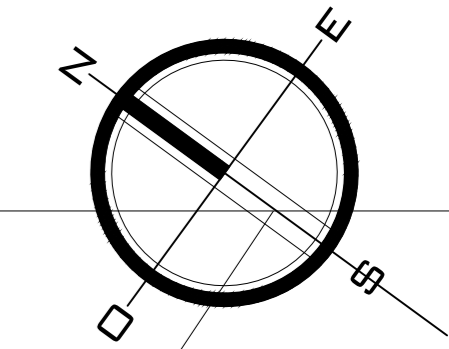

PROLONGACION DE LA AV. TARAPACA

CALLE 21

VIA PROYECTADA DE LA AVENIDA LA CULTURA

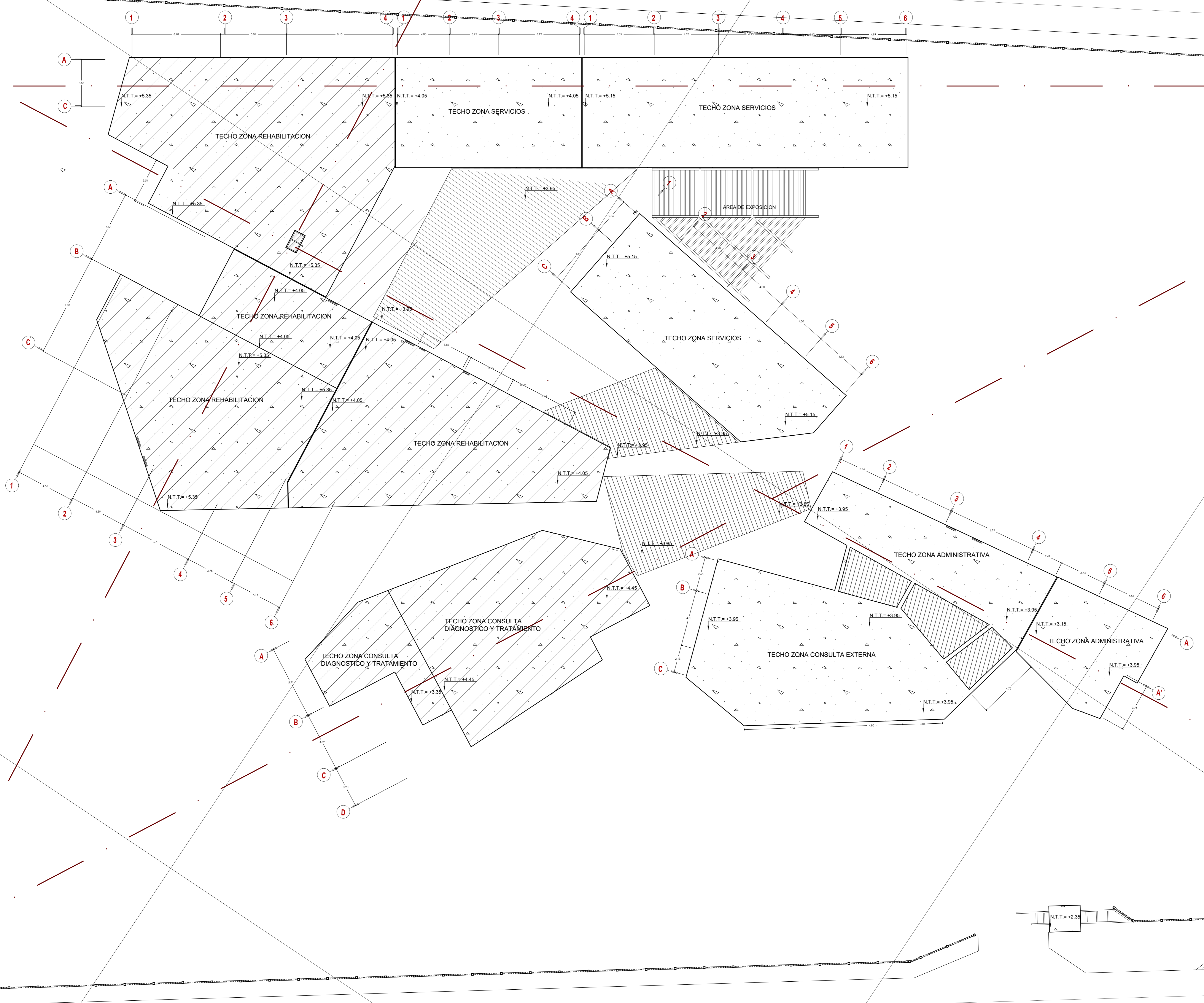

UNIVERSIDAD PRIVADA DE TACNA FACULTAD DE ARQUITECTURA Y URBANISMO			
CENTRO DE ATENCIÓN INTEGRAL DE TERAPIA PARA EL ADULTO MAYOR CON DISCAPACIDAD FÍSICA MOTORA EN EL DEPARTAMENTO DE TACNA-2017			
V - TALLER TUTORIAL DE TESIS			
PLANO: TRAZADO			
ARQ. EDGAR MIGUEL HINOJOSA VEGA	TESISTA:	BACH. ARQ. ROYDAN FRANCO NOA	
ESCALA: 1/125	FECHA: MARZO 2018	N° de LÁMINA: A-03	

