

**CUADRO DE ACABADOS**

MATERIAL	PISO		CANTONAJOS		PARED Y REVESTIMIENTO		CUBO		PINTURA										ACABADO				
	TIPO	ESPESES	TIPO	ESPESES	TIPO	ESPESES	TIPO	ESPESES	INTERIORES	EXTERIORES	PUERTAS	VENTANAS	TEJADOS	TEJADOS	TEJADOS	TEJADOS	TEJADOS	TEJADOS	TEJADOS	TEJADOS			
ABASTECIDOS																							
PRIMER NIVEL	S. UNIDAD DE REHABILITACION FISICA	SALA DE ESPERA	•	•	•	•	•	•	•	•	•	•	•	•	•	•	•	•	•	•	•		
		VESTIBULO	•	•	•	•	•	•	•	•	•	•	•	•	•	•	•	•	•	•	•	•	
		CIRCULACION PERSONAL	•	•	•	•	•	•	•	•	•	•	•	•	•	•	•	•	•	•	•	•	
		SALA DE HIDROTERAPIA MIEMBROS INFERIORES	•	•	•	•	•	•	•	•	•	•	•	•	•	•	•	•	•	•	•	•	
		SALA DE HIDROTERAPIA MIEMBROS SUPERIORES	•	•	•	•	•	•	•	•	•	•	•	•	•	•	•	•	•	•	•	•	
		ALMACEN INTERMEDIO RESIDUOS SOLIDOS	•	•	•	•	•	•	•	•	•	•	•	•	•	•	•	•	•	•	•	•	•
		VESTIBULOS	•	•	•	•	•	•	•	•	•	•	•	•	•	•	•	•	•	•	•	•	•
		JEFATURA	•	•	•	•	•	•	•	•	•	•	•	•	•	•	•	•	•	•	•	•	•
		ARCHIVO	•	•	•	•	•	•	•	•	•	•	•	•	•	•	•	•	•	•	•	•	•
		SALA DE FISIOTERAPIA	•	•	•	•	•	•	•	•	•	•	•	•	•	•	•	•	•	•	•	•	•
		SALA TERAPIA ORTOPEIDIA Y TRAUMATOLOGIA ADULTOS Y NIÑOS	•	•	•	•	•	•	•	•	•	•	•	•	•	•	•	•	•	•	•	•	•
		SALA TERAPIA NEUROREHABILITACION ADULTOS Y NIÑOS	•	•	•	•	•	•	•	•	•	•	•	•	•	•	•	•	•	•	•	•	•
SEGUNDO NIVEL	S. UNIDAD DE REHABILITACION FISICA	CAFETERIA	•	•	•	•	•	•	•	•	•	•	•	•	•	•	•	•	•	•	•	•	
		COCINETA	•	•	•	•	•	•	•	•	•	•	•	•	•	•	•	•	•	•	•	•	
		CAJA	•	•	•	•	•	•	•	•	•	•	•	•	•	•	•	•	•	•	•	•	
		ASCENSOR	•	•	•	•	•	•	•	•	•	•	•	•	•	•	•	•	•	•	•	•	
		TALLER CONFECCION DE ORTETICOS	•	•	•	•	•	•	•	•	•	•	•	•	•	•	•	•	•	•	•	•	
		ALMACEN EQUIPOS Y MATERIAL	•	•	•	•	•	•	•	•	•	•	•	•	•	•	•	•	•	•	•	•	
		SALA DE ESPERA	•	•	•	•	•	•	•	•	•	•	•	•	•	•	•	•	•	•	•	•	
		SALA DE ESPERA	•	•	•	•	•	•	•	•	•	•	•	•	•	•	•	•	•	•	•	•	
		SALA DE ESPERA	•	•	•	•	•	•	•	•	•	•	•	•	•	•	•	•	•	•	•	•	
		SALA DE ESPERA	•	•	•	•	•	•	•	•	•	•	•	•	•	•	•	•	•	•	•	•	
		SALA DE ESPERA	•	•	•	•	•	•	•	•	•	•	•	•	•	•	•	•	•	•	•	•	

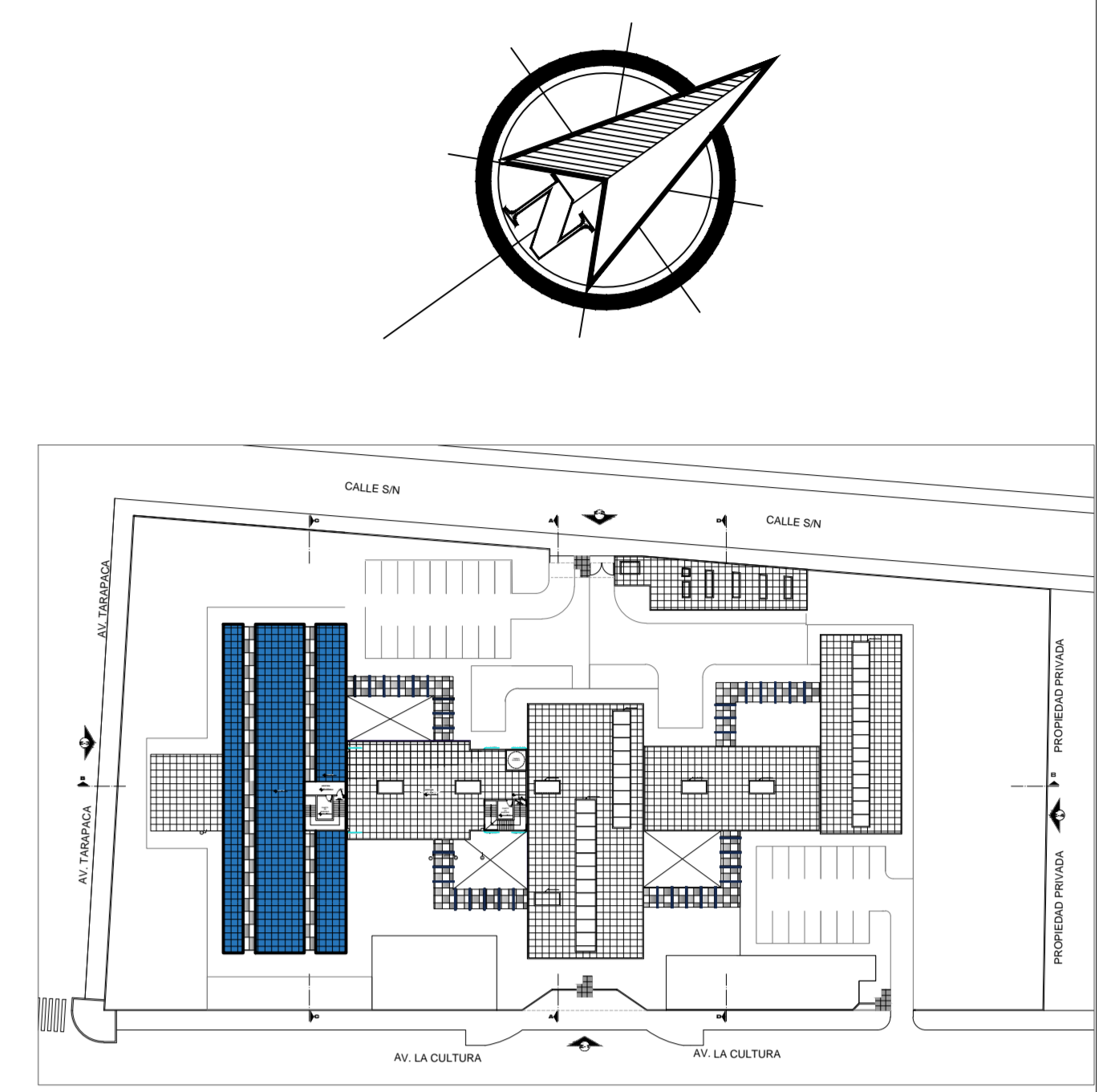

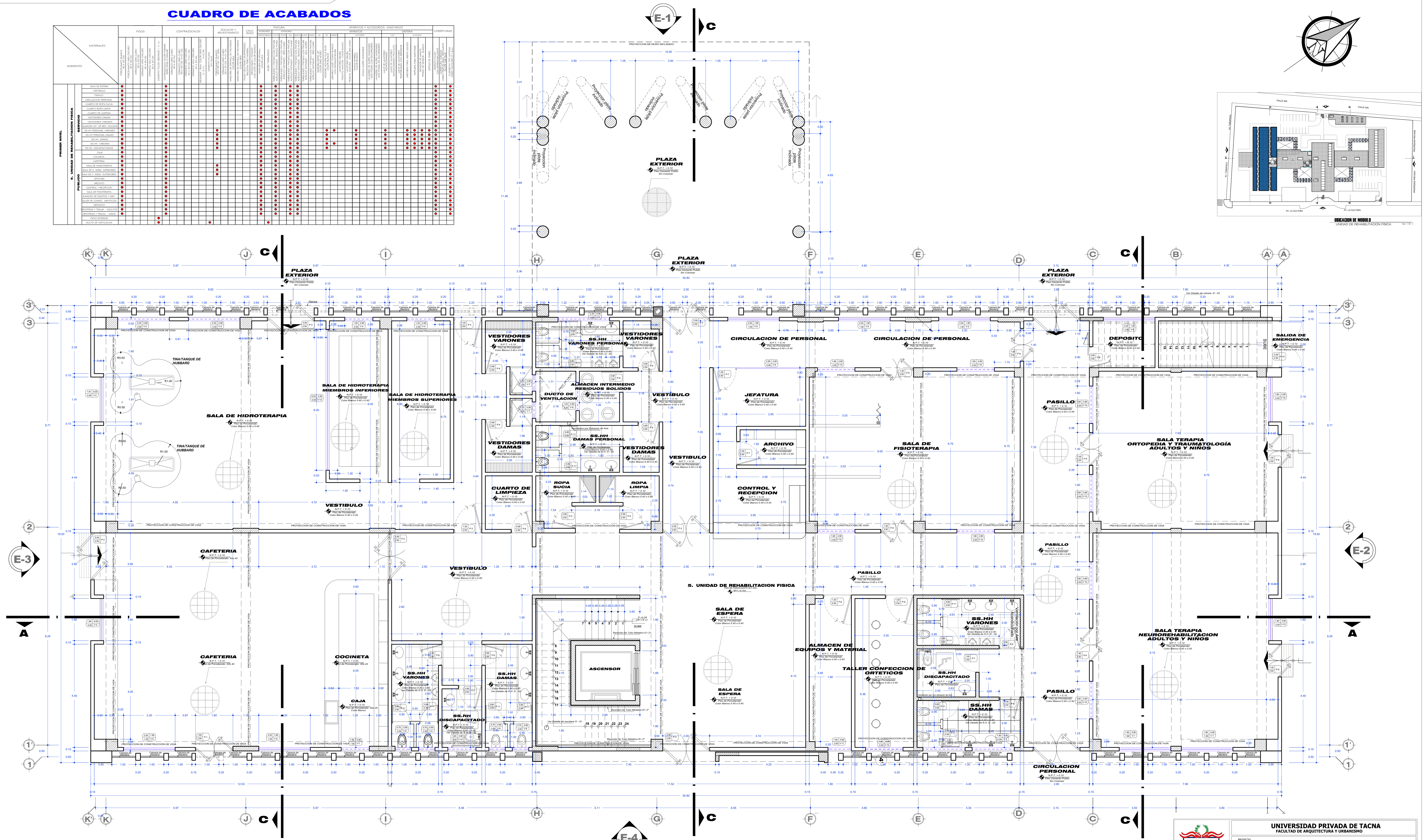

### CUADRO DE ACABADOS

MATERIAS	PISO	CONTRAPISO	ZONAS Y REVESTIMIENTOS	FRONTERAS	FRONTERAS Y ACCESORIOS	CUBIERTURAS	DETALLES	MUEBLES	TUBERIA	PINTURAS	CERAMICOS	VIDRIOS	MATERIAS
ALUMINIO													
ACRYLICO													
ALUMINIO													
ALUMINIO													
ALUMINIO													

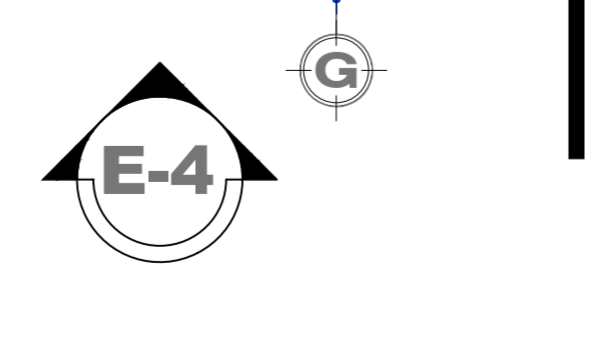
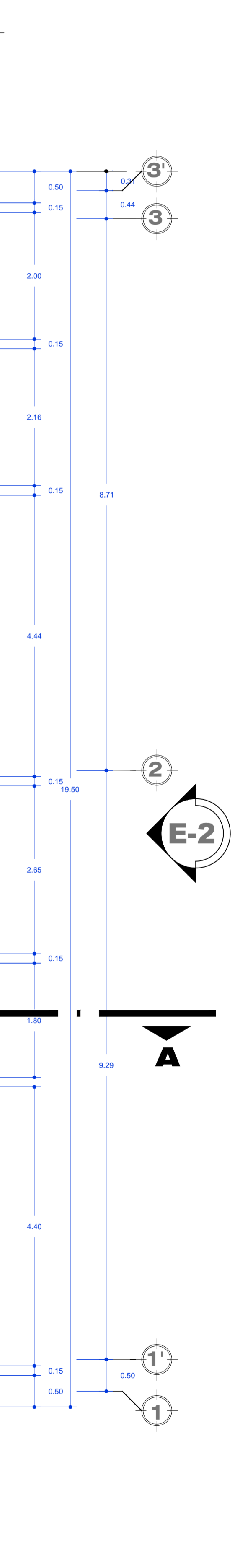
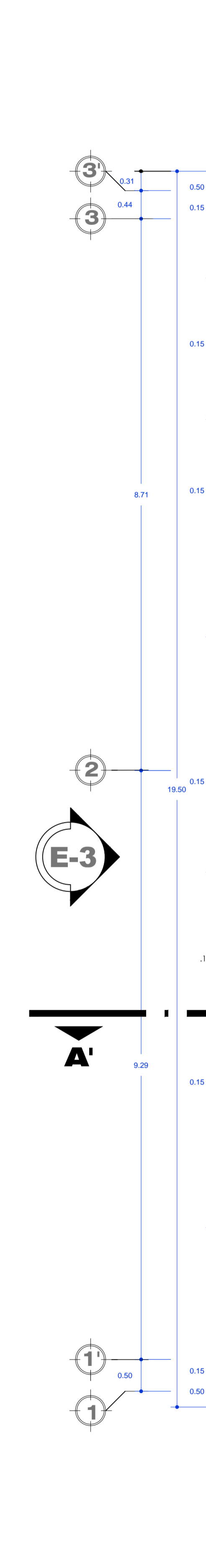
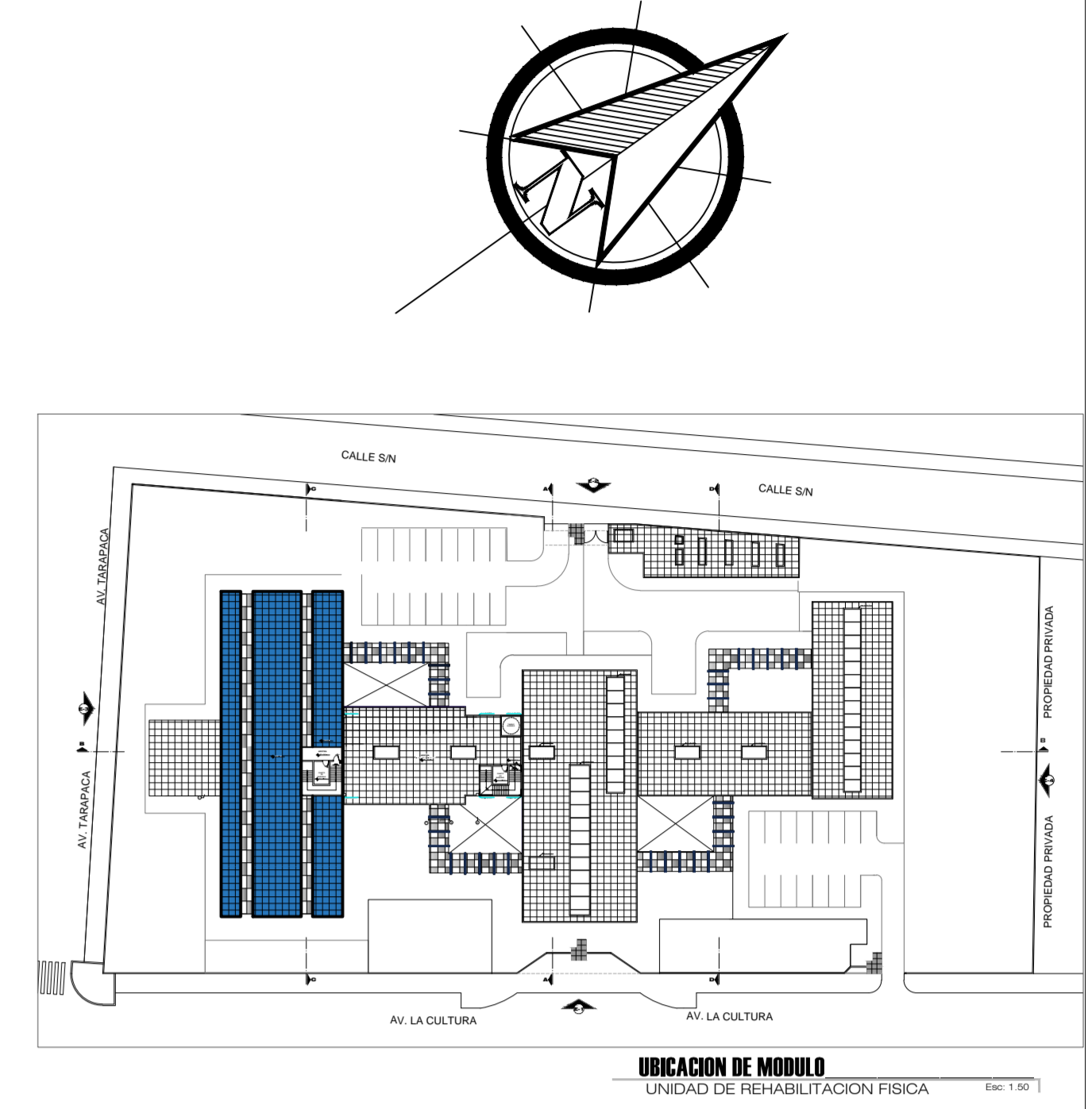
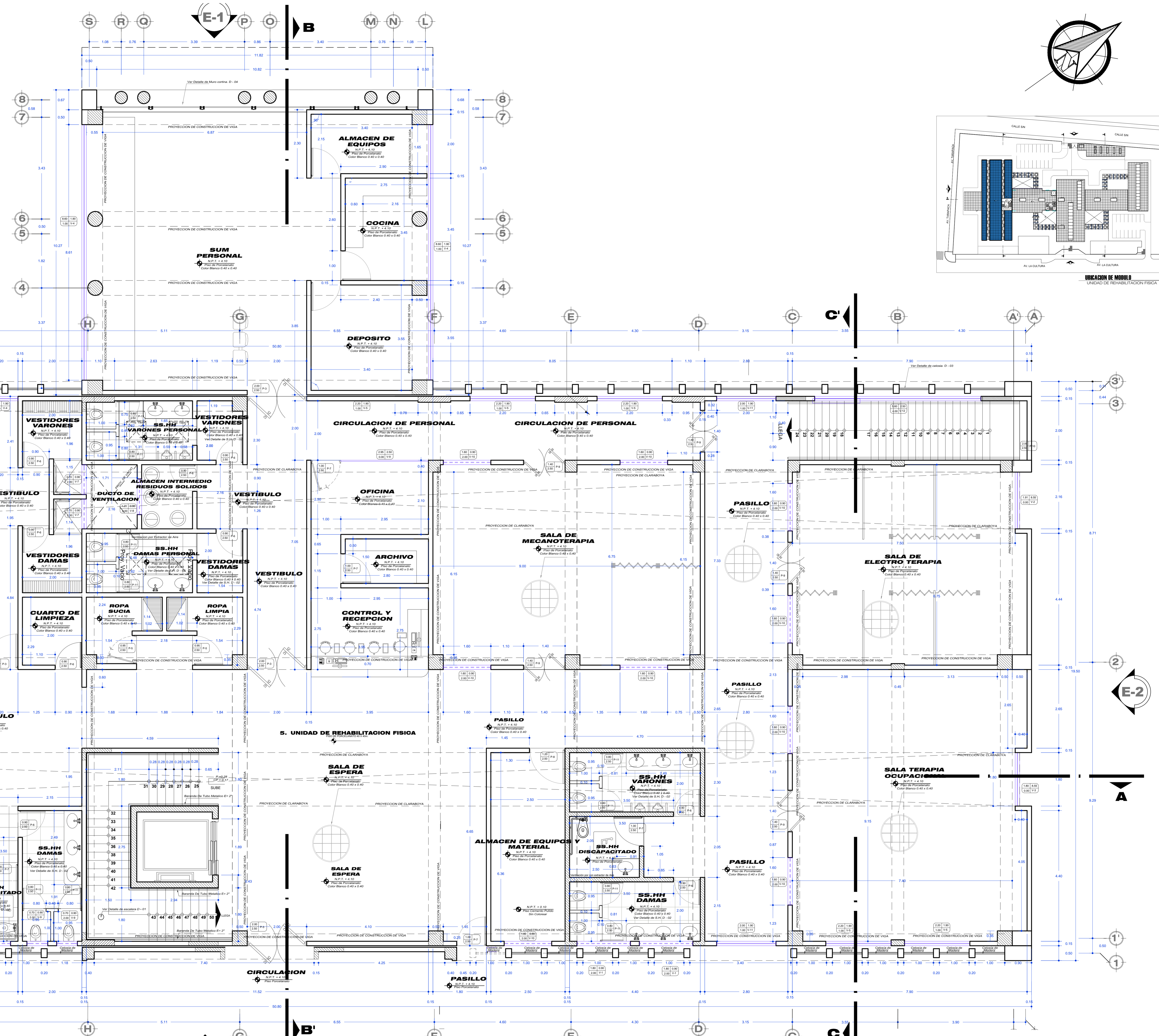



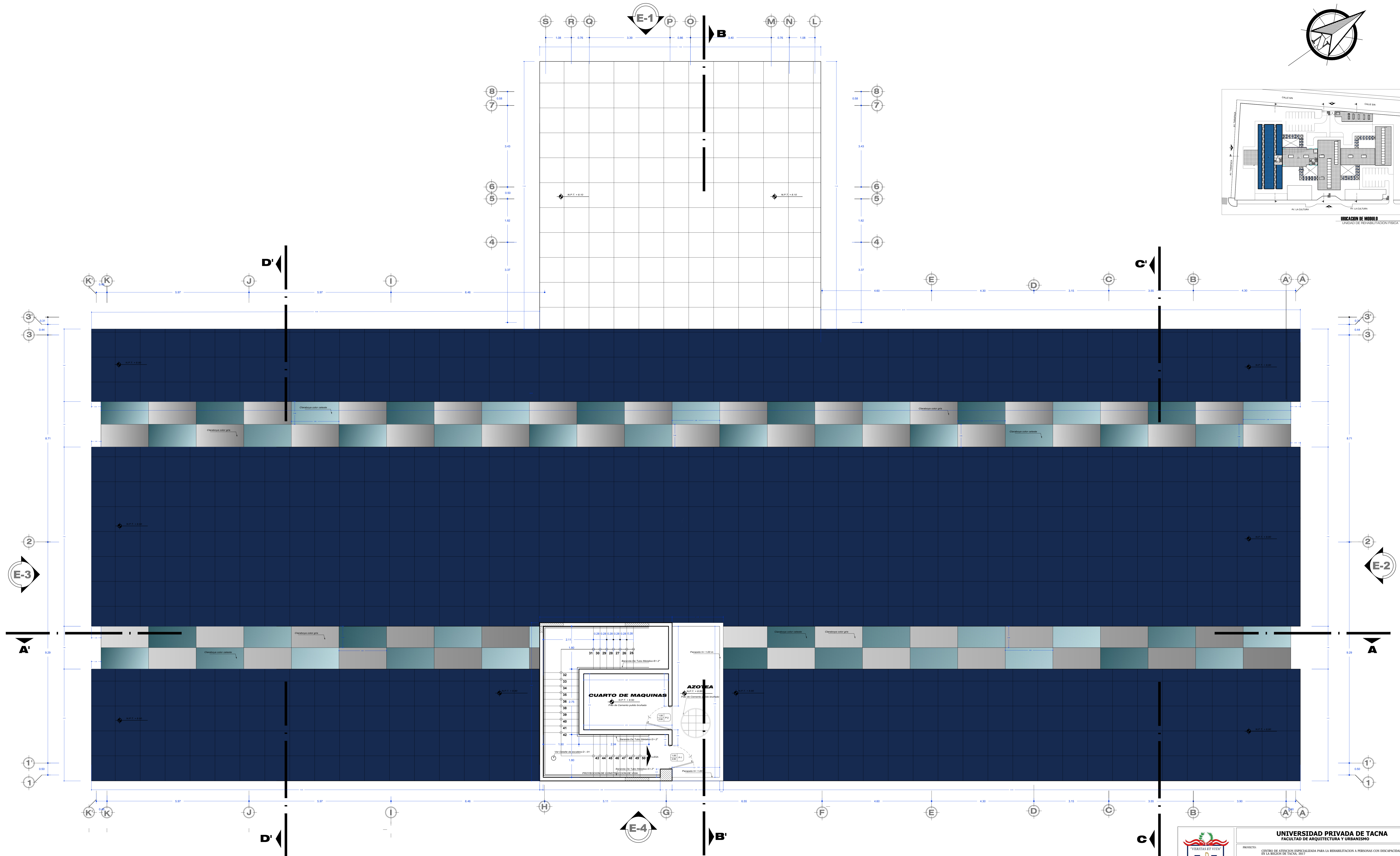
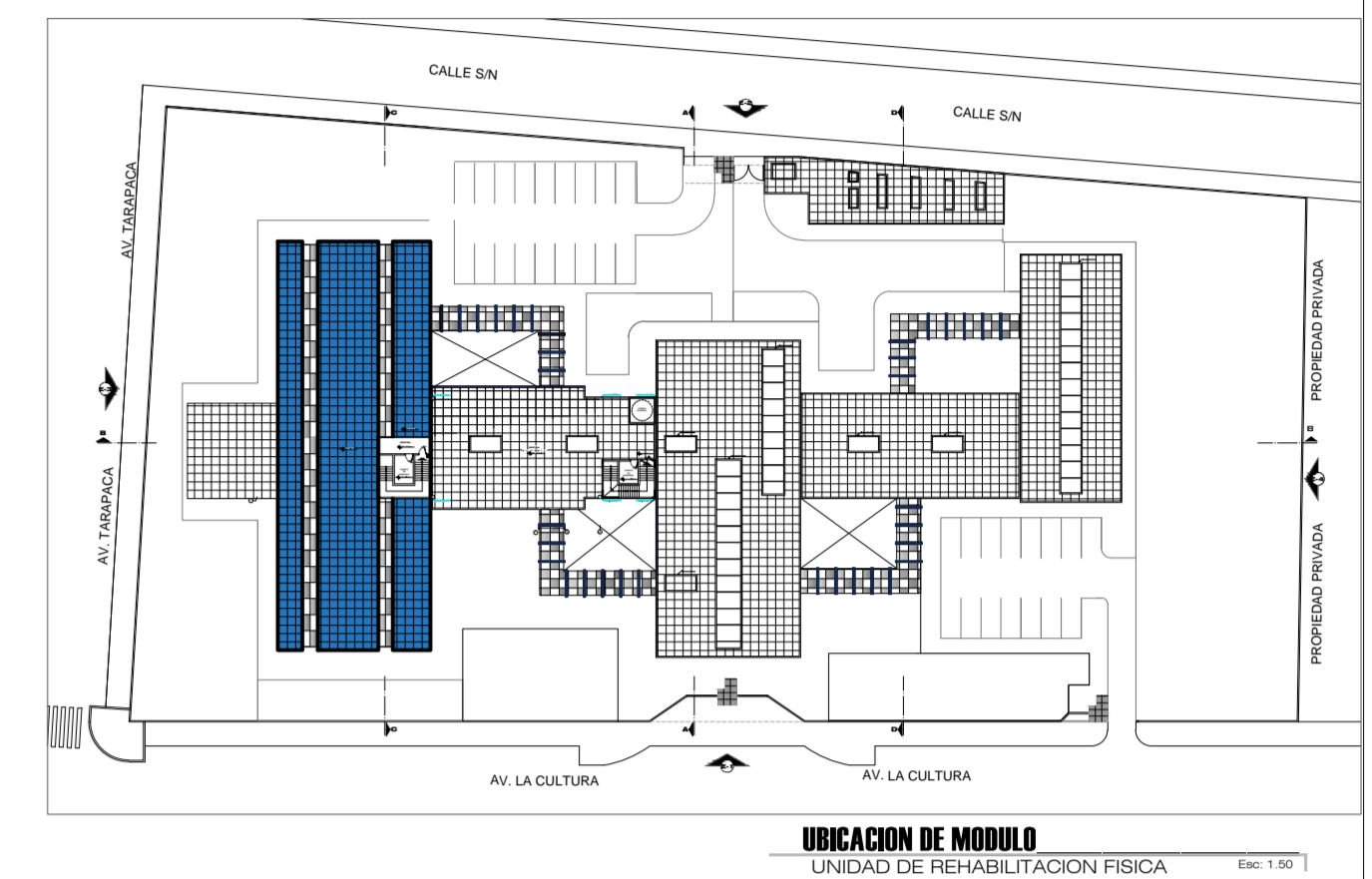
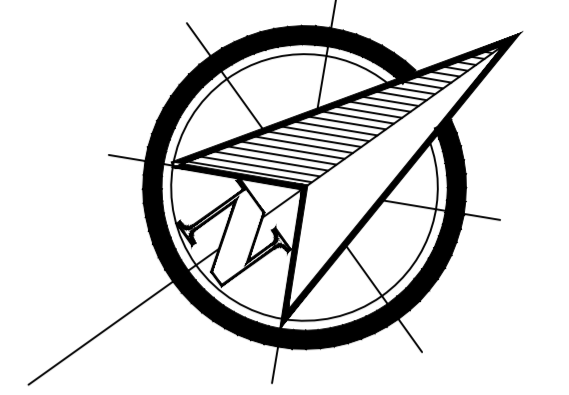

**PLANO DE DISTRIBUCION ARQUITECTONICA: TERCER NIVEL**  
UNIDAD DE REHABILITACION FISICA Esc: 1:50

	<b>UNIVERSIDAD PRIVADA DE TACNA</b> FACULTAD DE ARQUITECTURA Y URBANISMO			No. de LÁMINA: <b>A-11</b>	
	PROYECTO: CENTRO DE ATENCION ESPECIALIZADA PARA LA REHABILITACION A PERSONAS CON DISCAPACIDAD FISICA EN LA REGION DE TACNA, 2017				
	V TALLER TUTORIAL DE TESIS				
	PLANO: TERCER NIVEL				
AUTOR: ARQ. ROSA TORRES MIRANDA	TITULO: BACH. ARQ. MIGUEL ANGEL GOMEZ RODRIGUEZ				
ESCALA: 1:50	FECHA: MARZO - 2018				



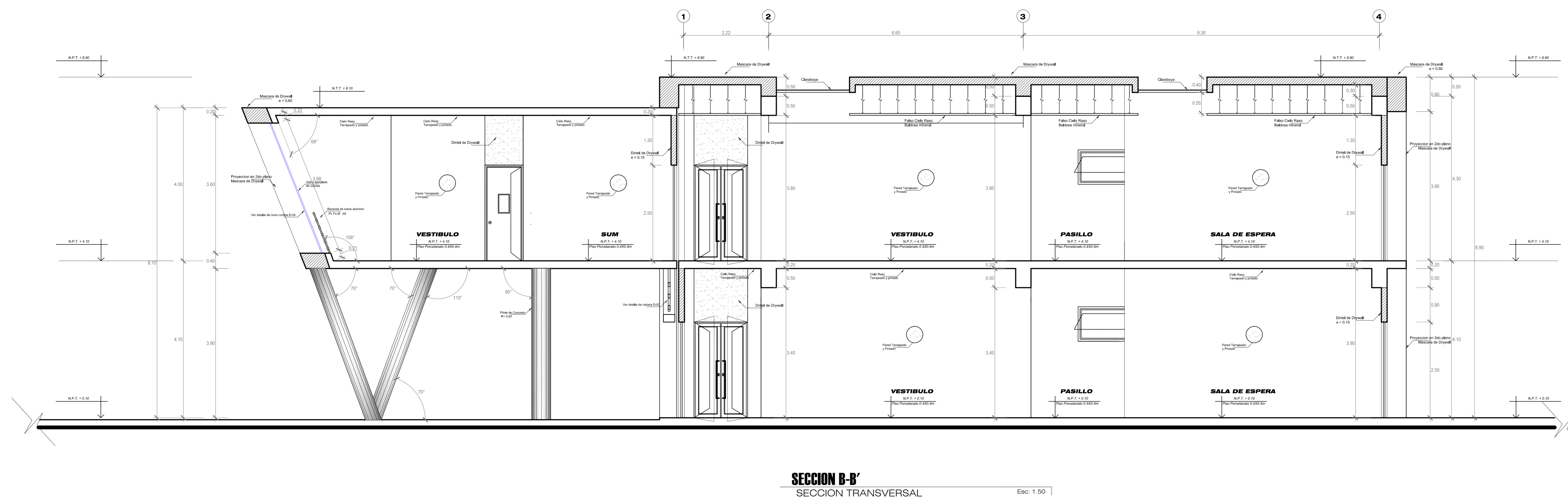
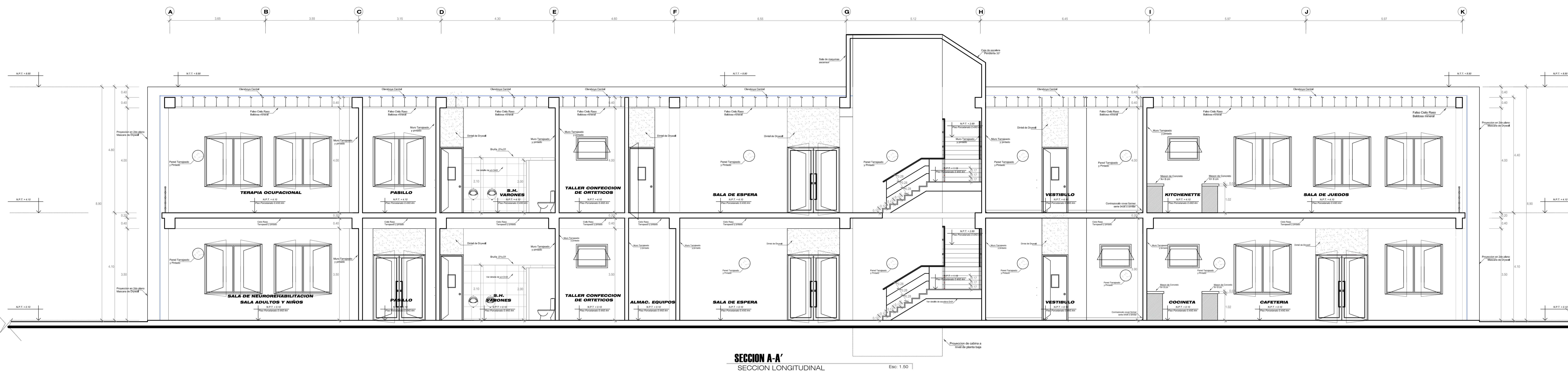



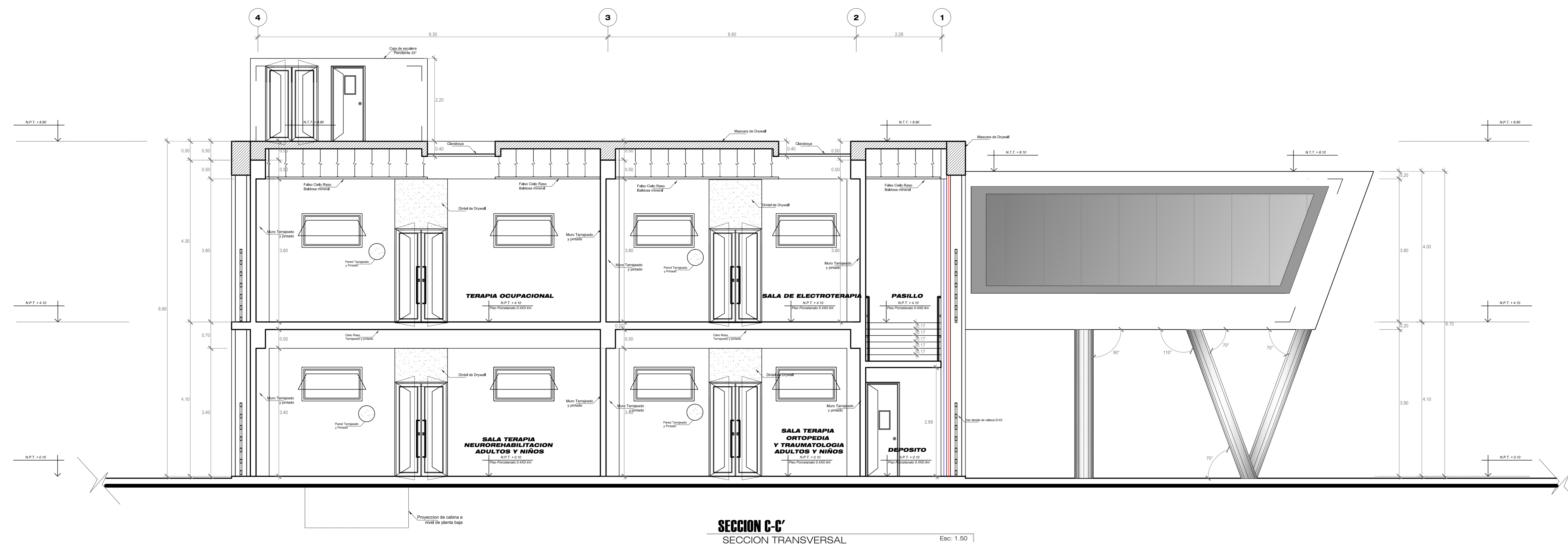



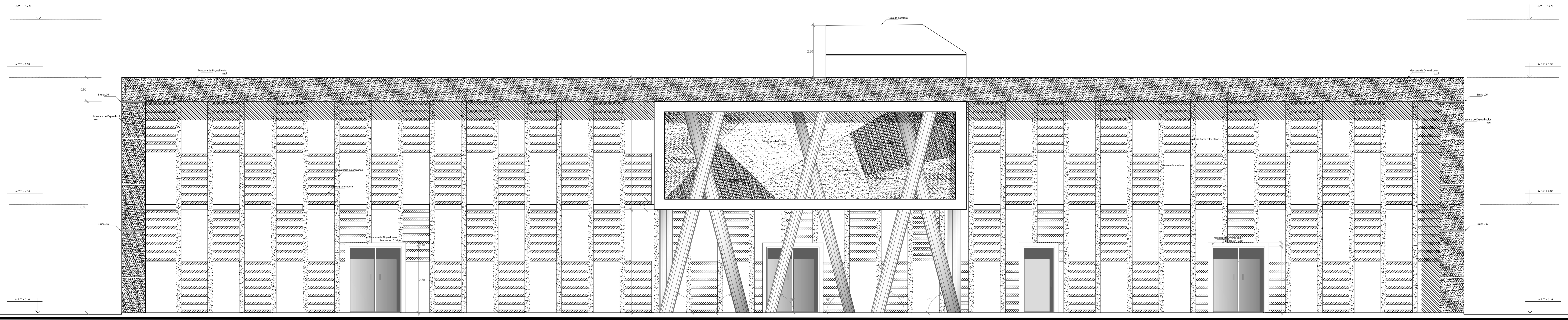

**ELEVACION FRONTAL E-1**  
Ebc: 1/50

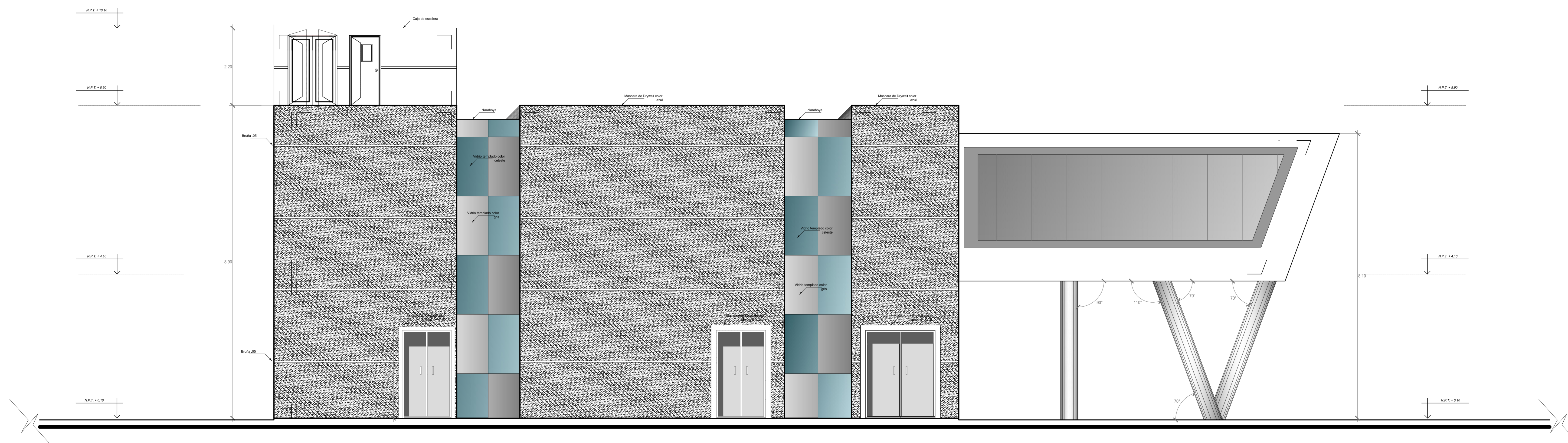

**ELEVACION LATERAL E-2**  
Ebc: 1/50



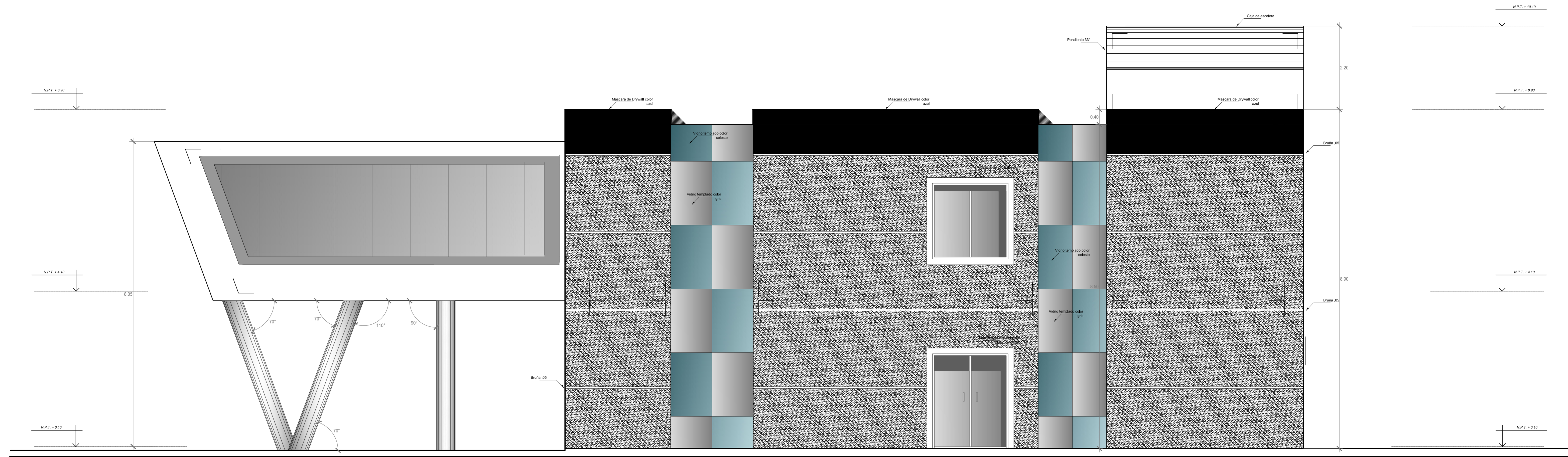

**ELEVACION LATERAL E-3**  
Escala: 1:50

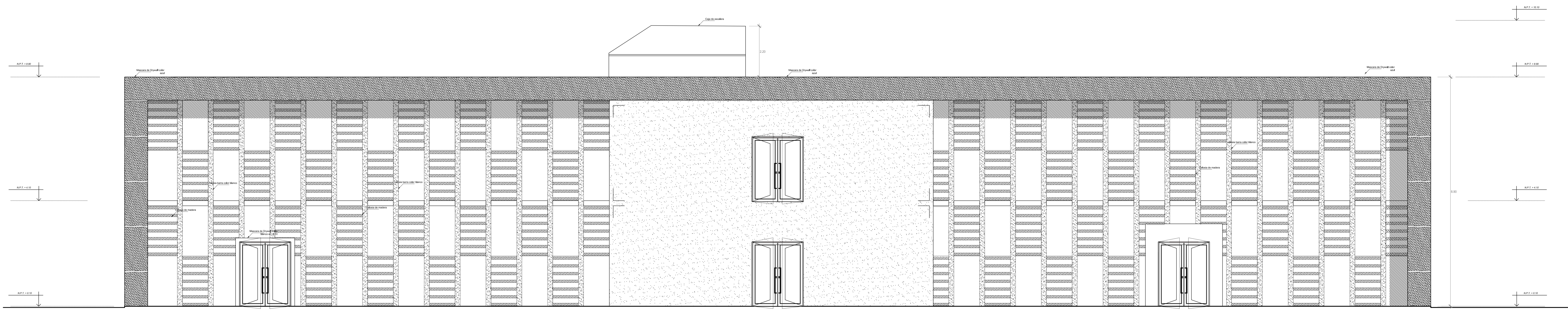

**ELEVACION POSTERIOR E-4**  
Escala: 1:50







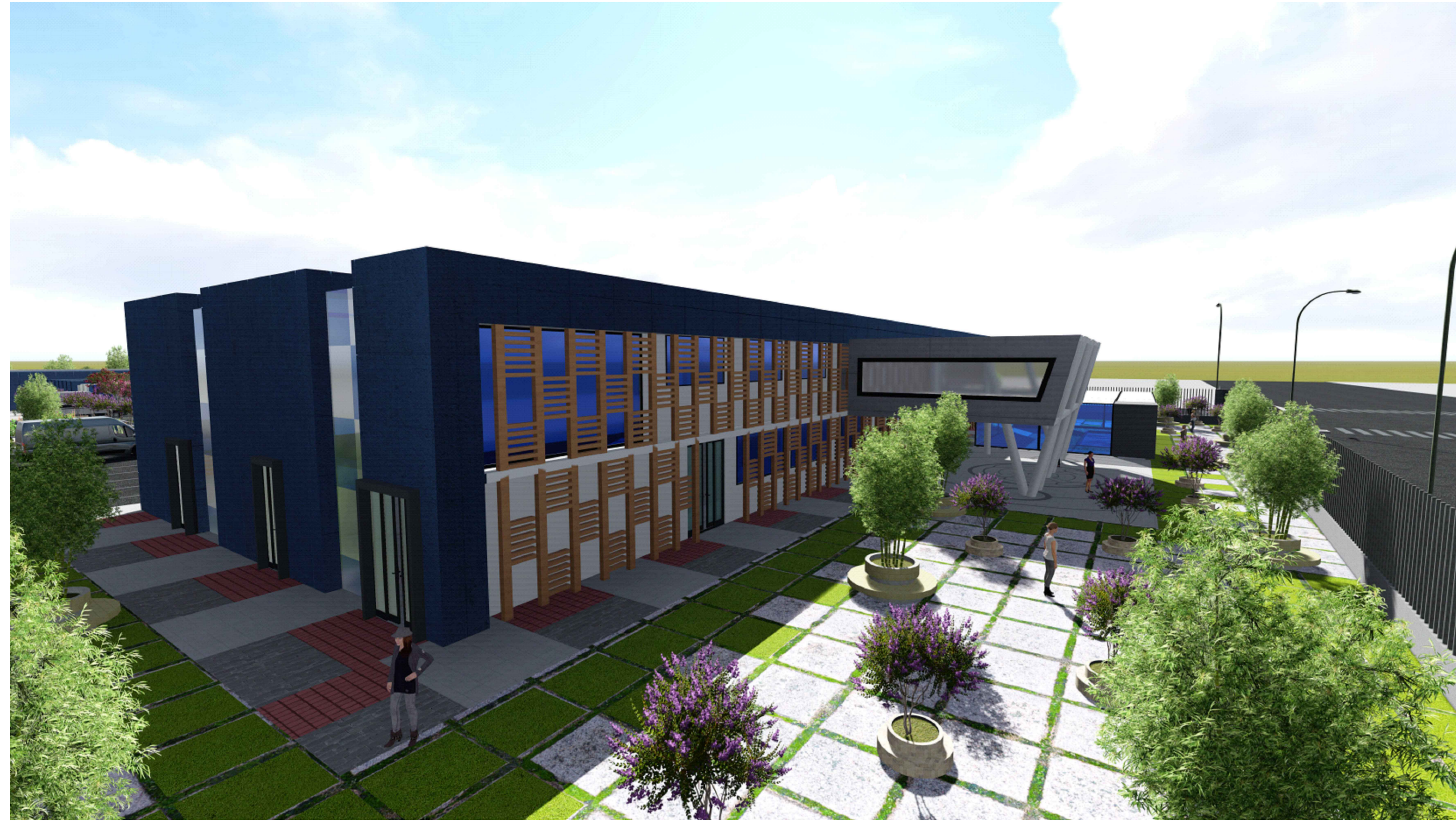

**VISTA EXTERIOR DE PROYECTO 01**



**VISTA EXTERIOR DE PROYECTO 02**



**VISTA EXTERIOR DE PROYECTO 03**



**VISTA INTERIOR DE PROYECTO 01**



**VISTA INTERIOR DE PROYECTO 02**



**VISTA INTERIOR DE PROYECTO 03**



#### DETALLE 02 : DE BAÑOS TIPO

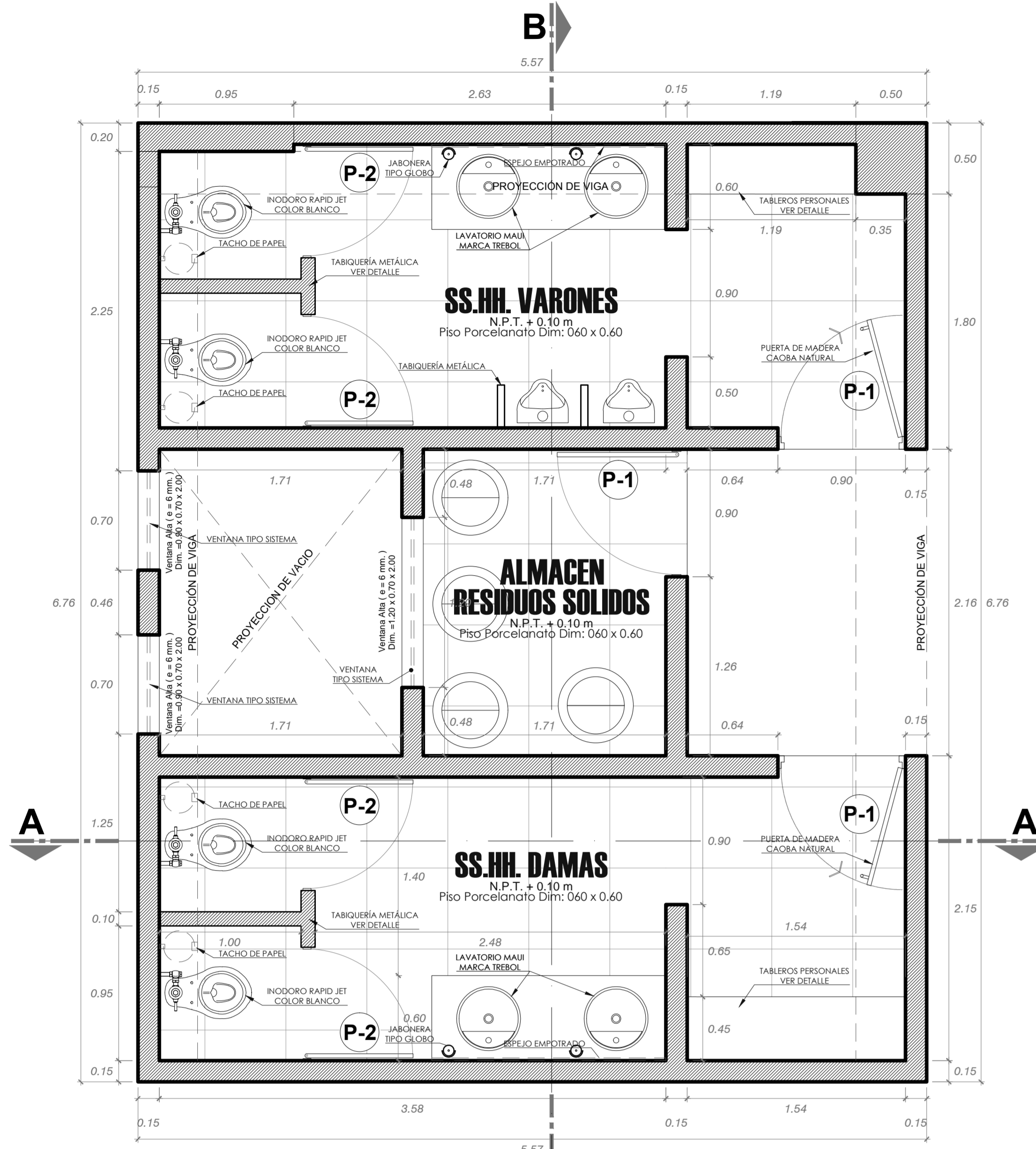

DETALLE DE BATERIA DE BAÑOS TIPO A ESC: 1/25

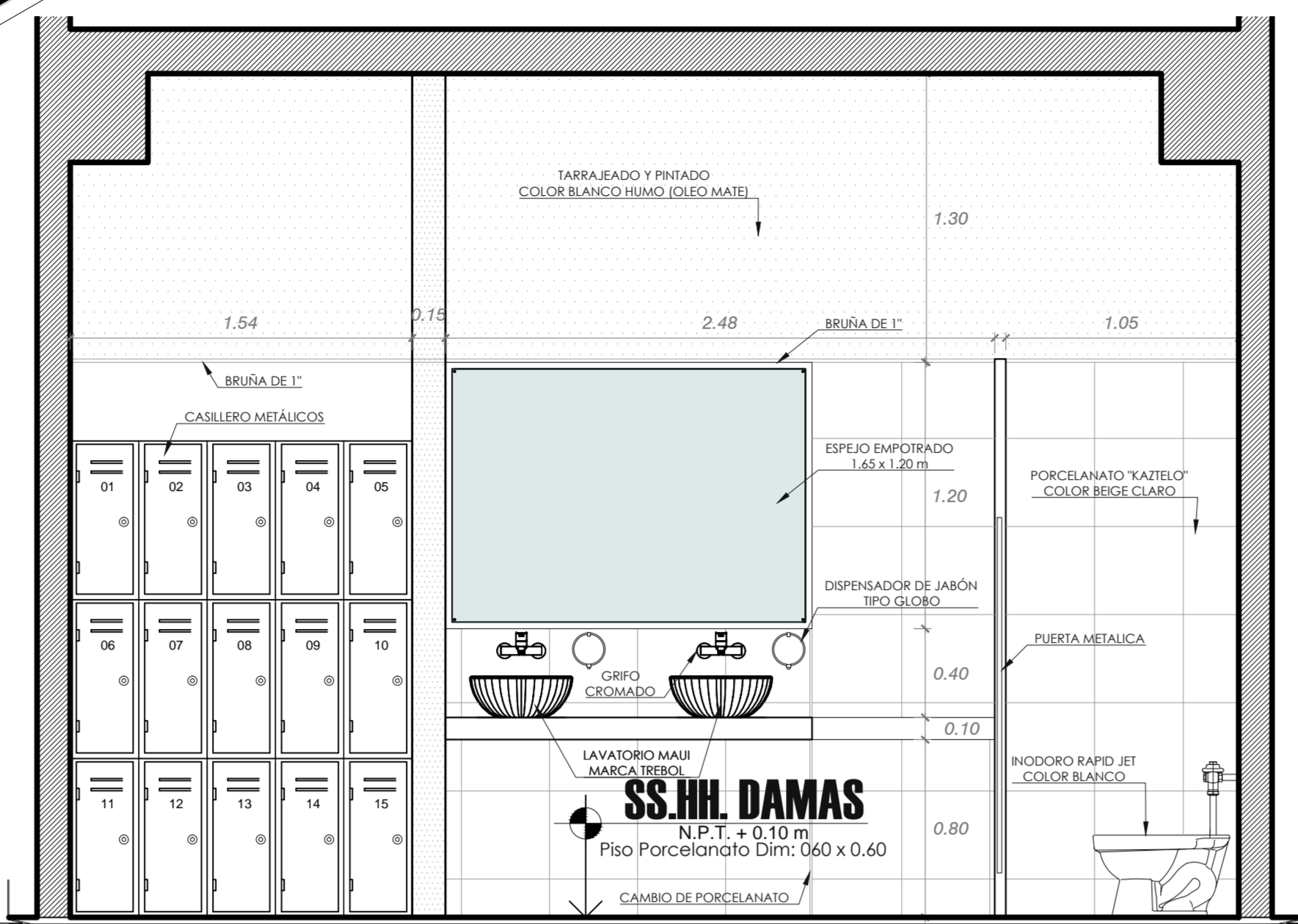

BATERIA DE BAÑOS TIPO A: CORTE A-A ESC: 1/25

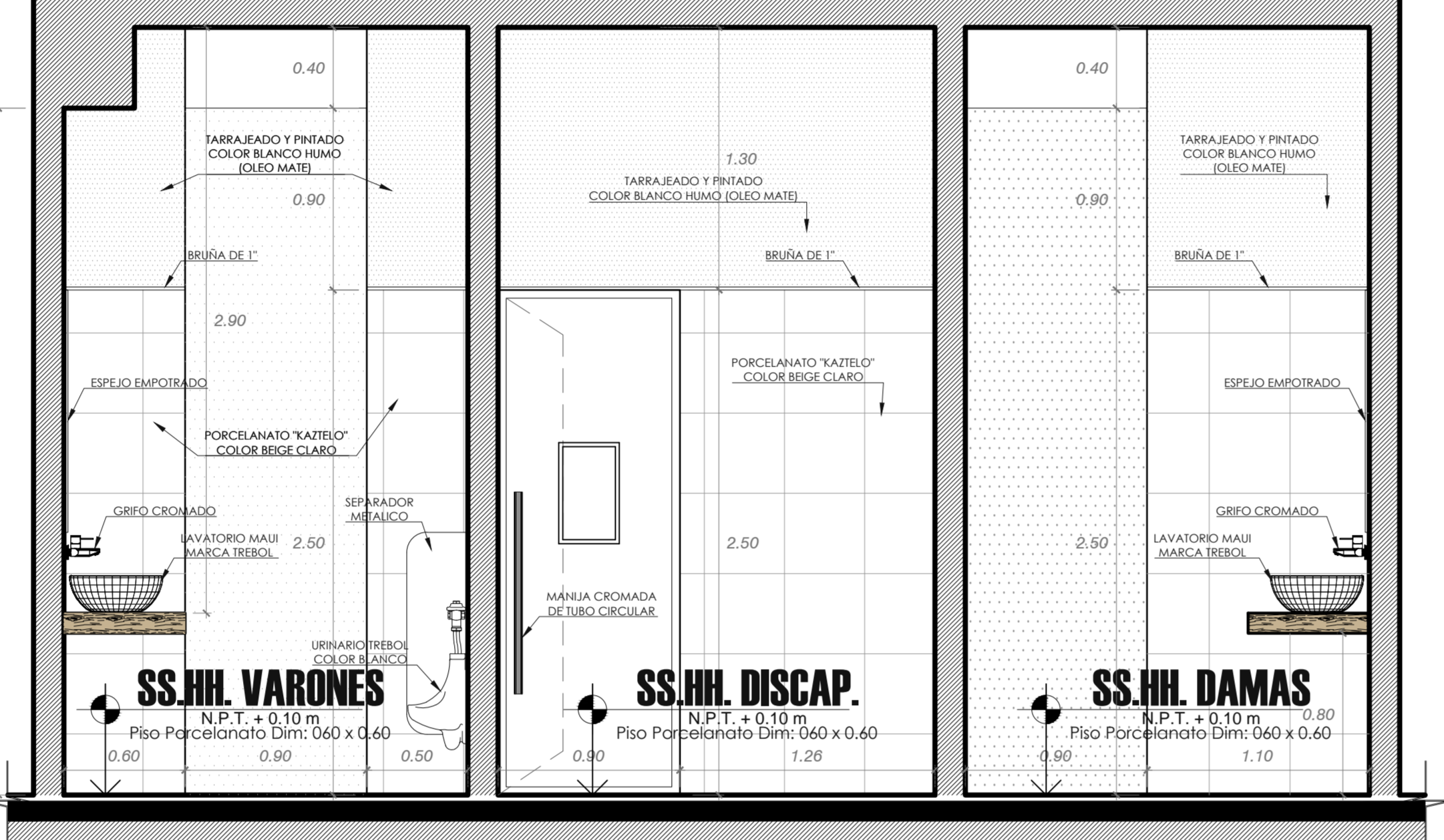

BATERIA DE BAÑOS TIPO A: CORTE B-B ESC: 1/25

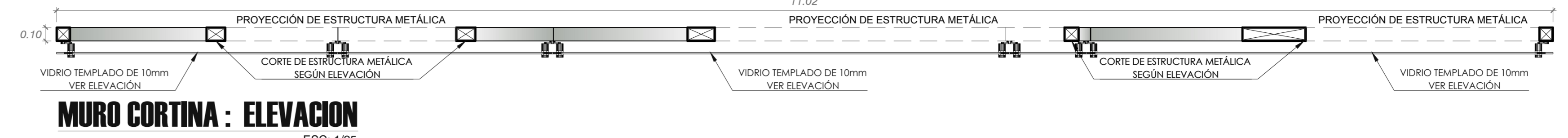

MURO CORTINA : ELEVACION ESC: 1/25

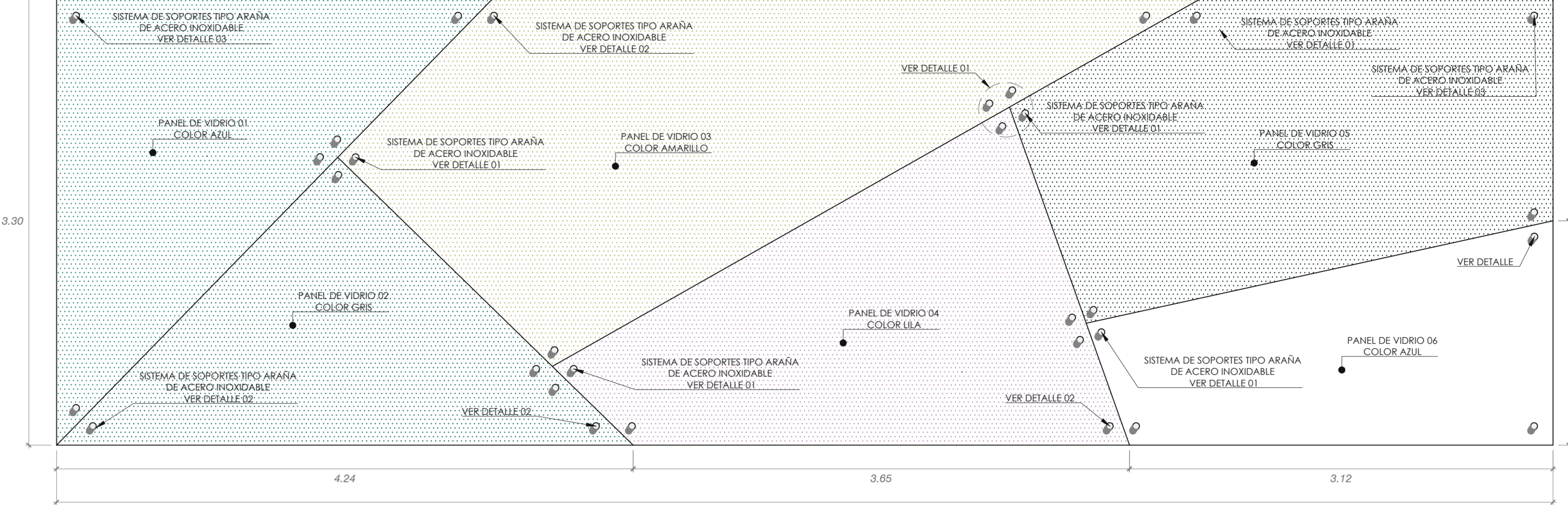

MURO CORTINA : ELEVACION ESC: 1/25

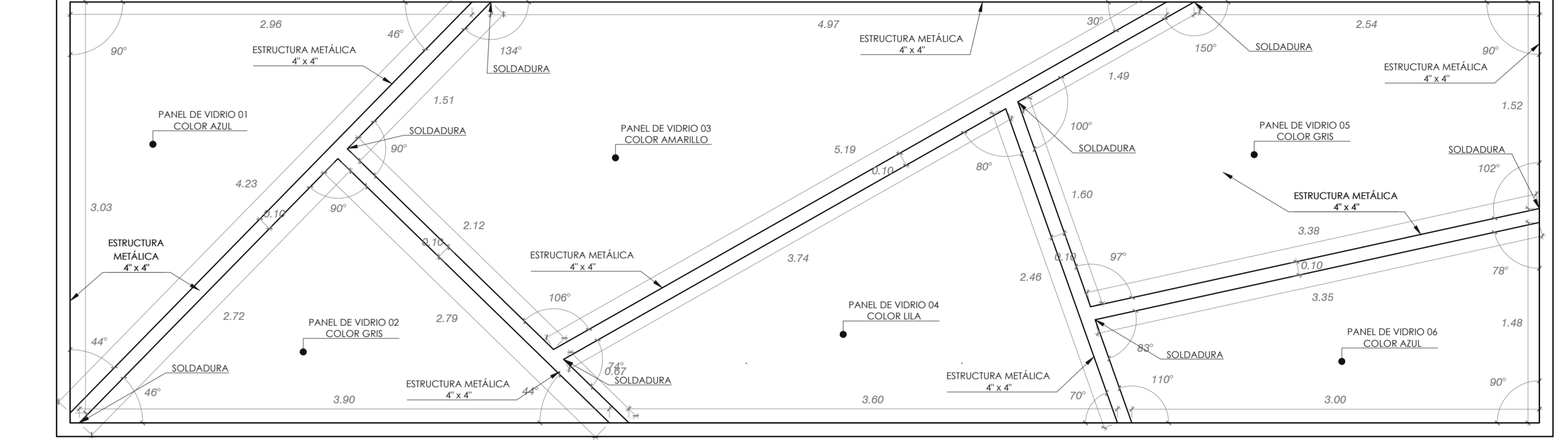

MURO CORTINA : ESTRUCTURA METALICA ESC: 1/25

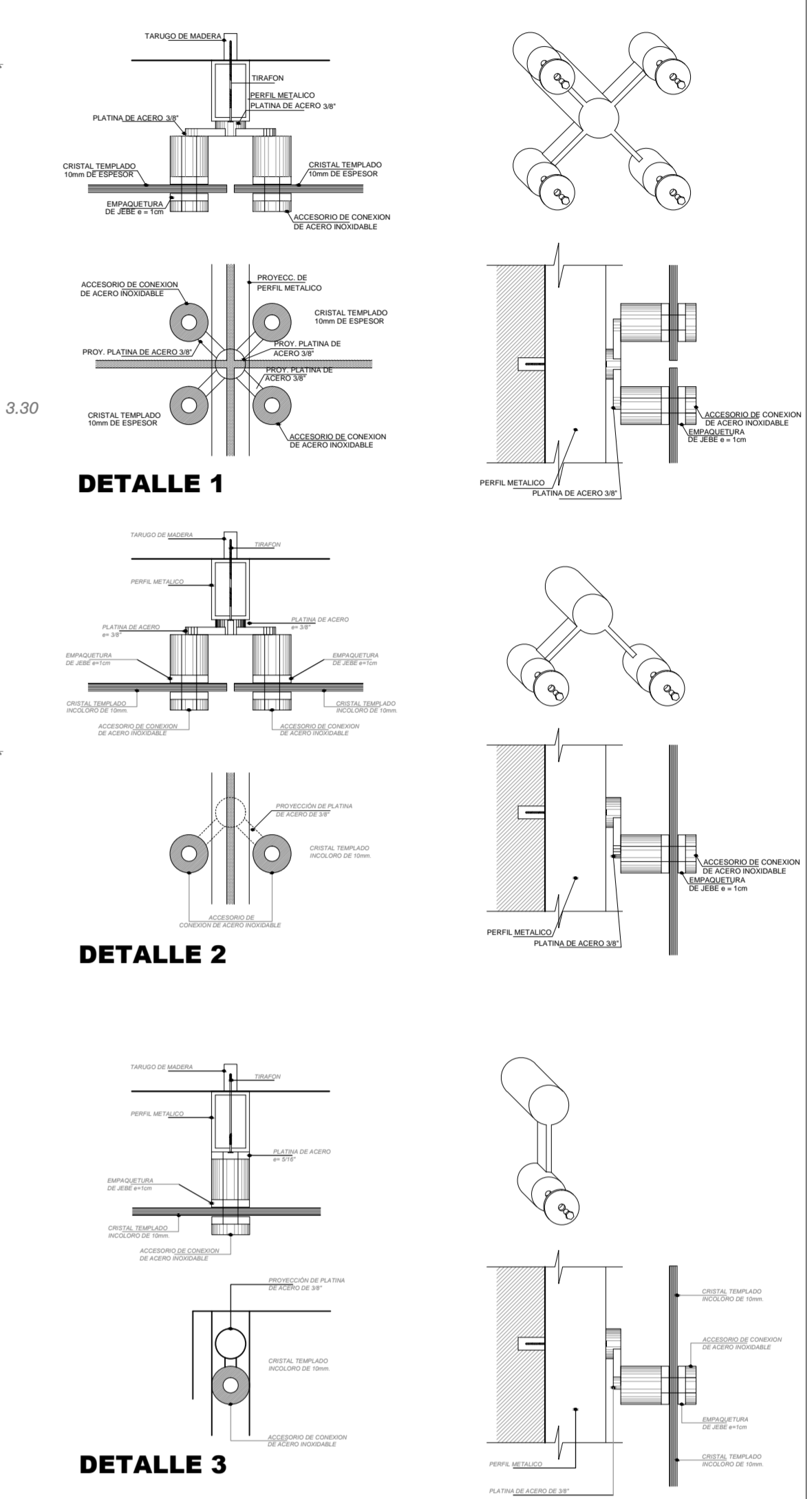

DETALLE 1  
DETALLE 2  
DETALLE 3

**CUADRO DE VANOS**

PUERTAS					
TIPO	ANCHO	ALTO	ALFEIZER	CANT.	OBSERVACIONES
P-1	0.90	2.50	-	3	PUERTA CONTRAPICADA DE MADERA CASERA NATURAL, DE UNA BATERIA, ACCESORIO TRANDOR Y MANEJO EN MADERA
P-2	0.80	2.50	-	4	PUERTA METALICA DE UNA BATERIA, ACCESORIO Y ACABADOS EN METAL

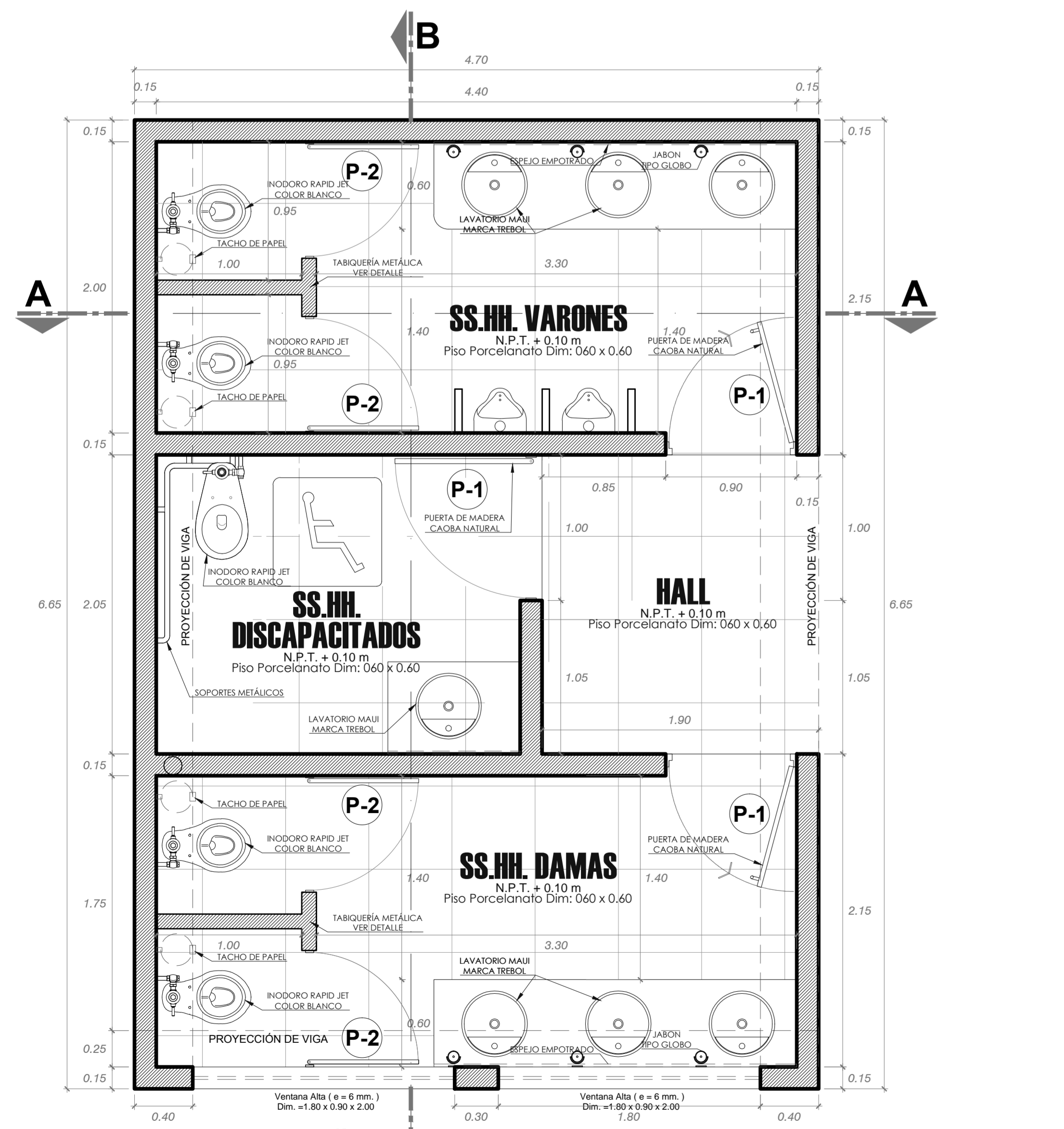

DETALLE DE BATERIA DE BAÑOS TIPO B ESC: 1/25

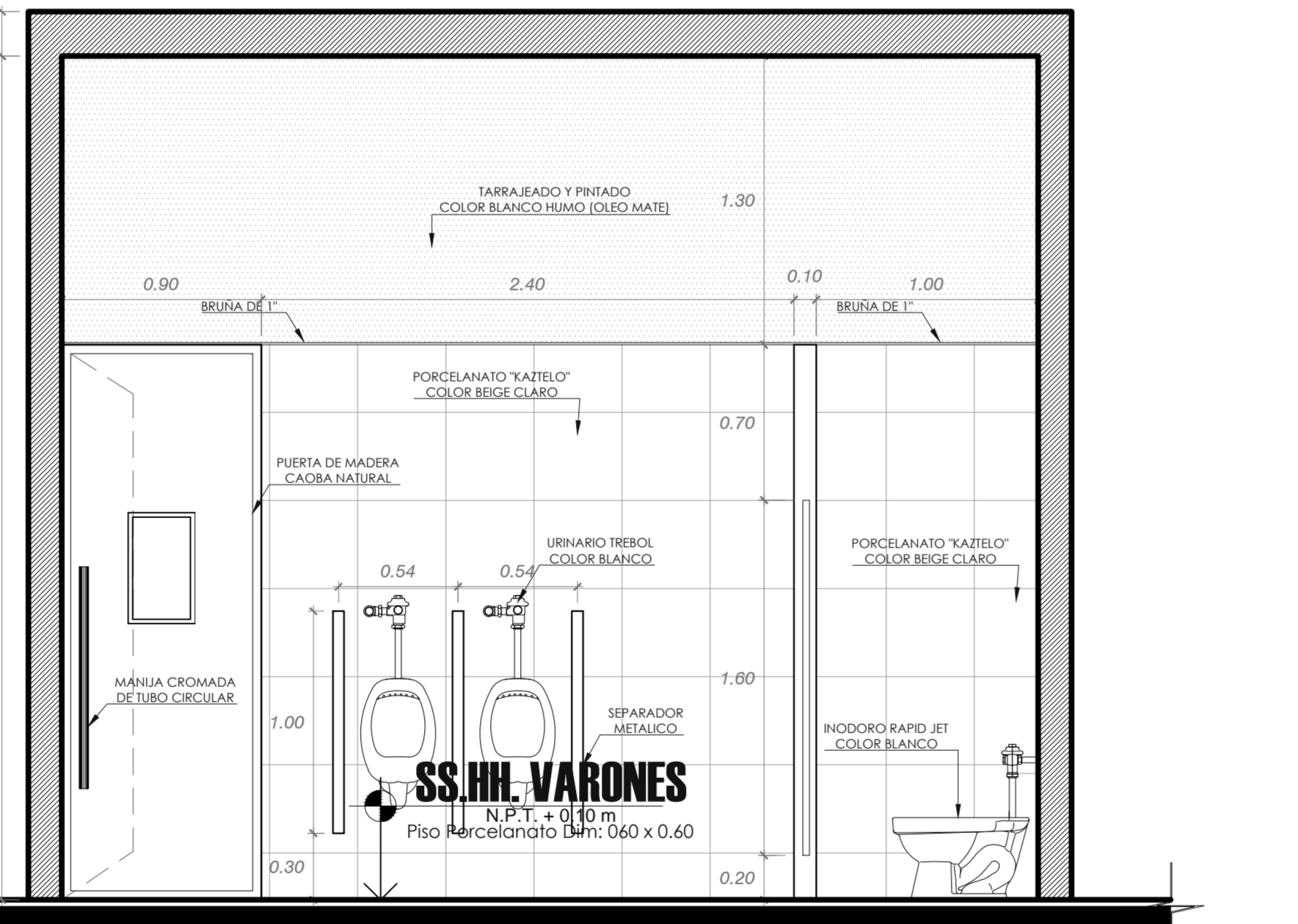

BATERIA DE BAÑOS TIPO B: CORTE A-A ESC: 1/25

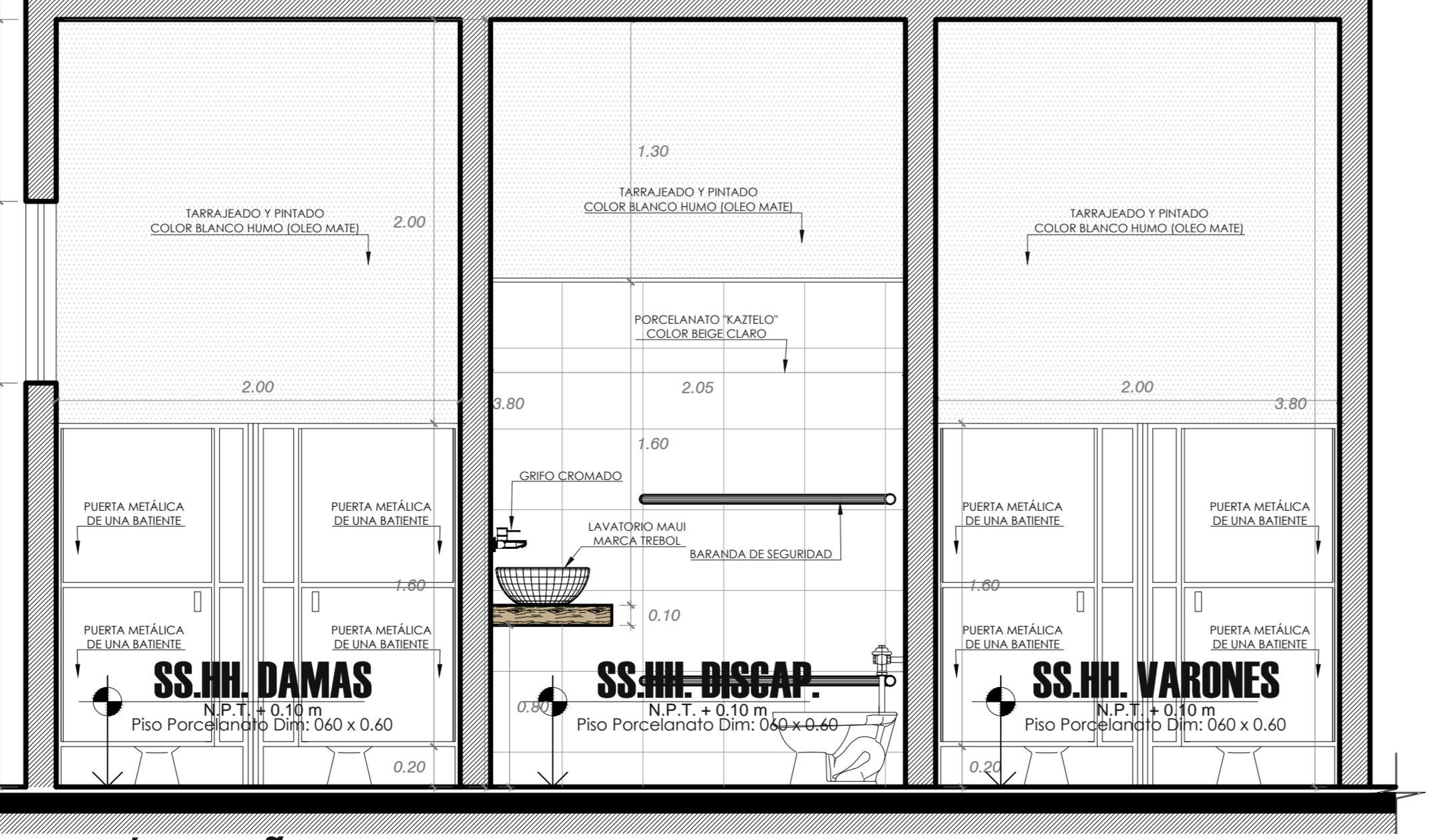

BATERIA DE BAÑOS TIPO B: CORTE B-B ESC: 1/25

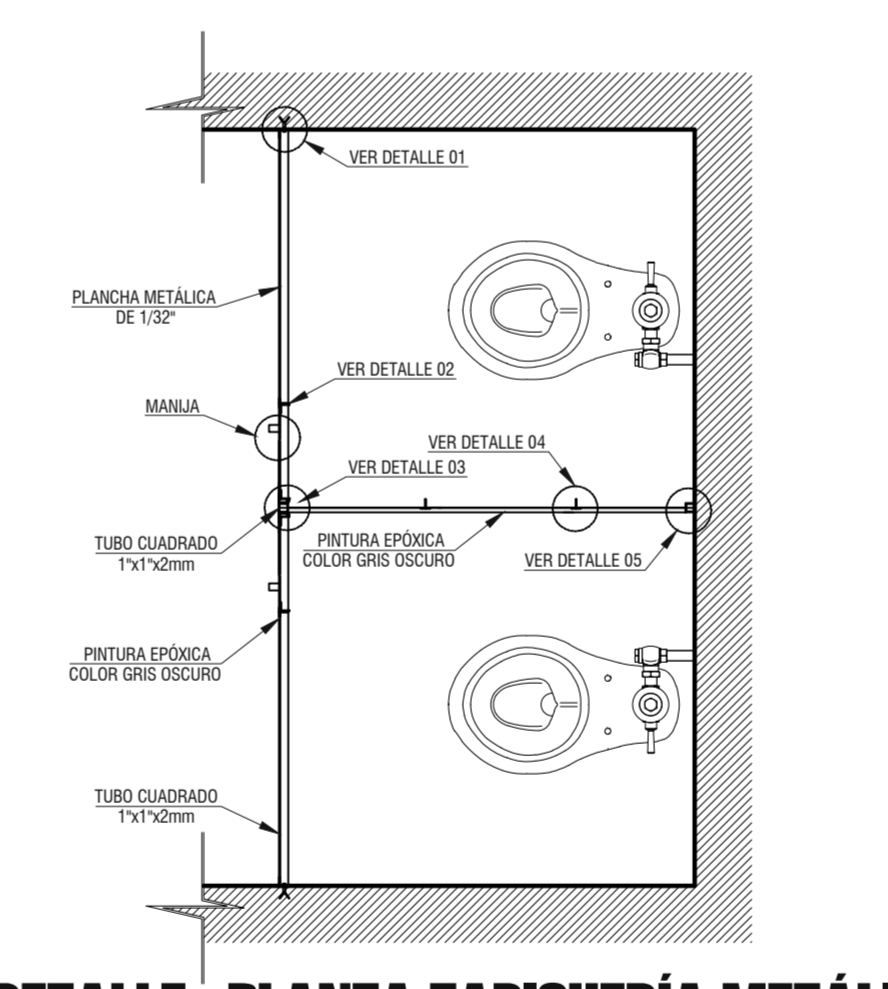

DETALLE: PLANTA TABIQUERIA METALICA ESC: 1/20

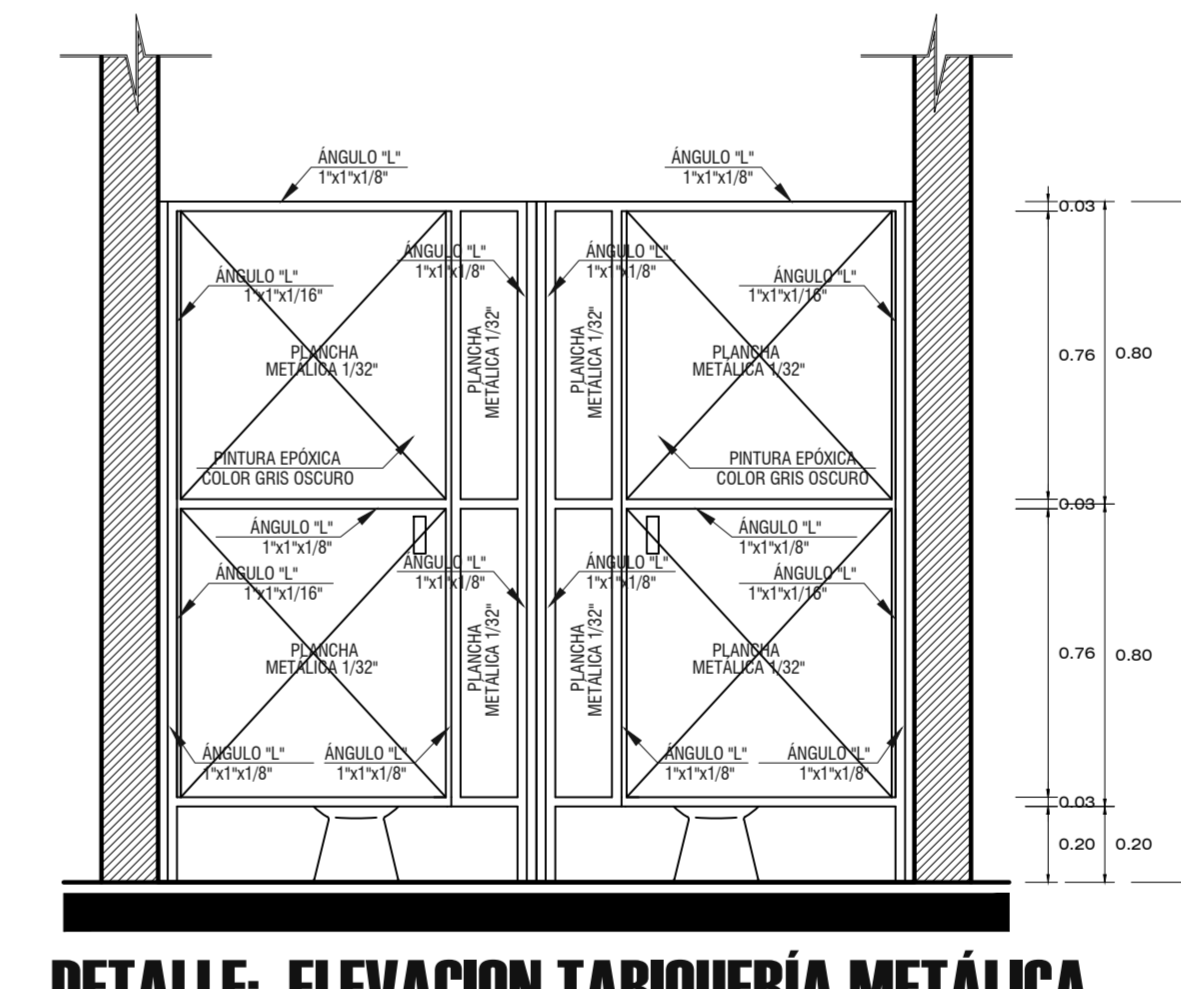

DETALLE: ELEVACION TABIQUERIA METALICA ESC: 1/20

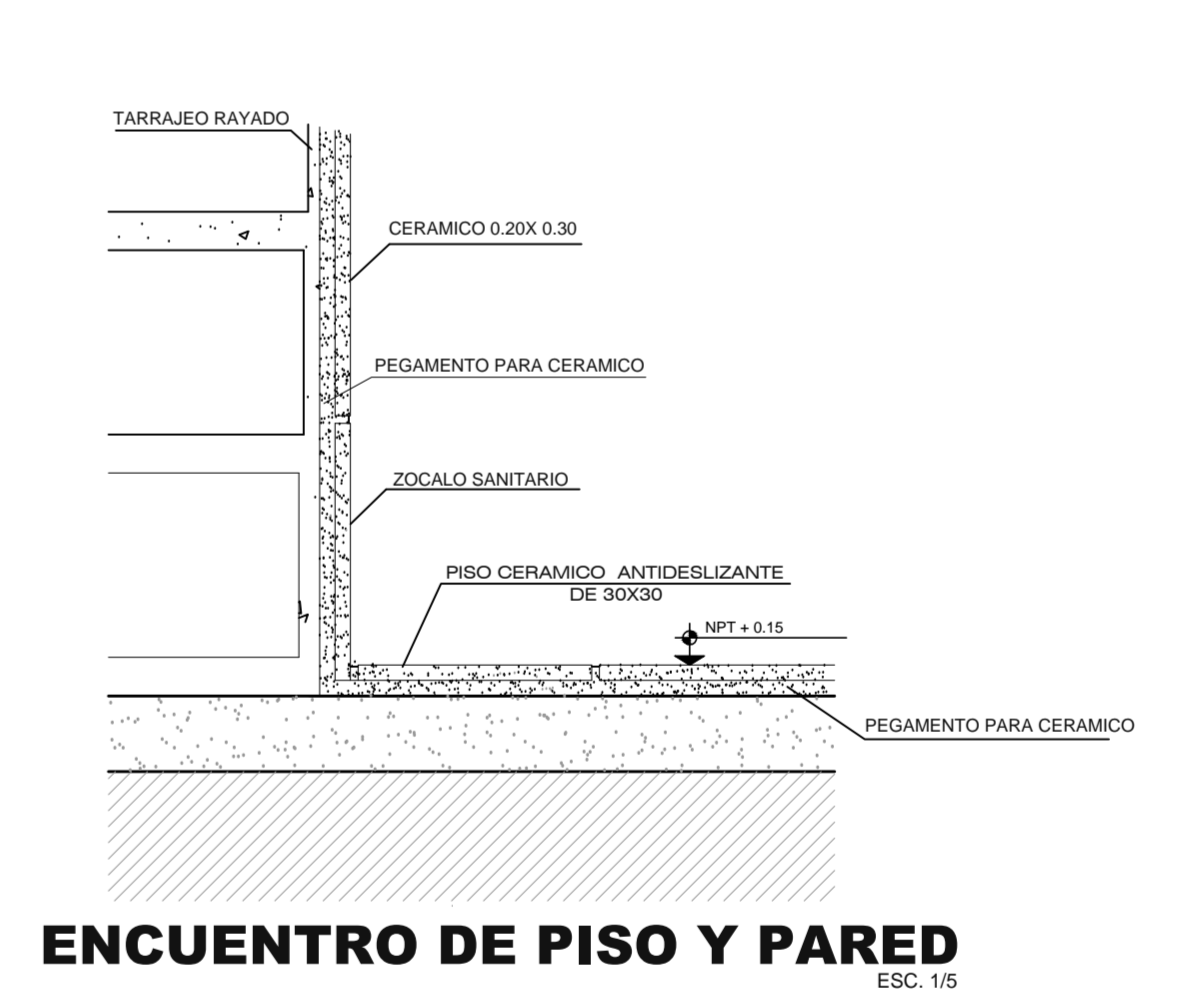

ENCUENTRO DE PISO Y PARED ESC: 1/5

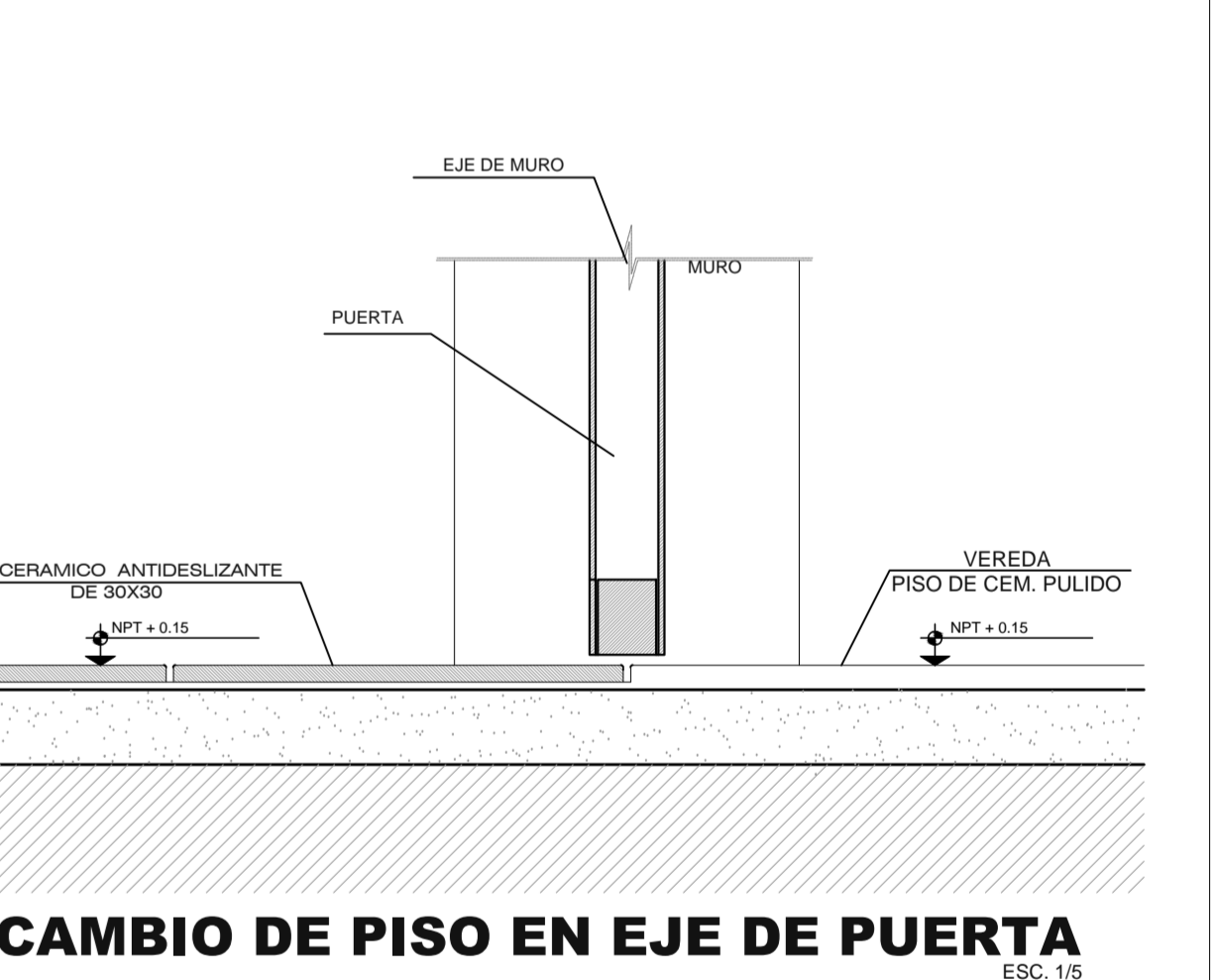

CAMBIO DE PISO EN EJE DE PUERTA ESC: 1/5

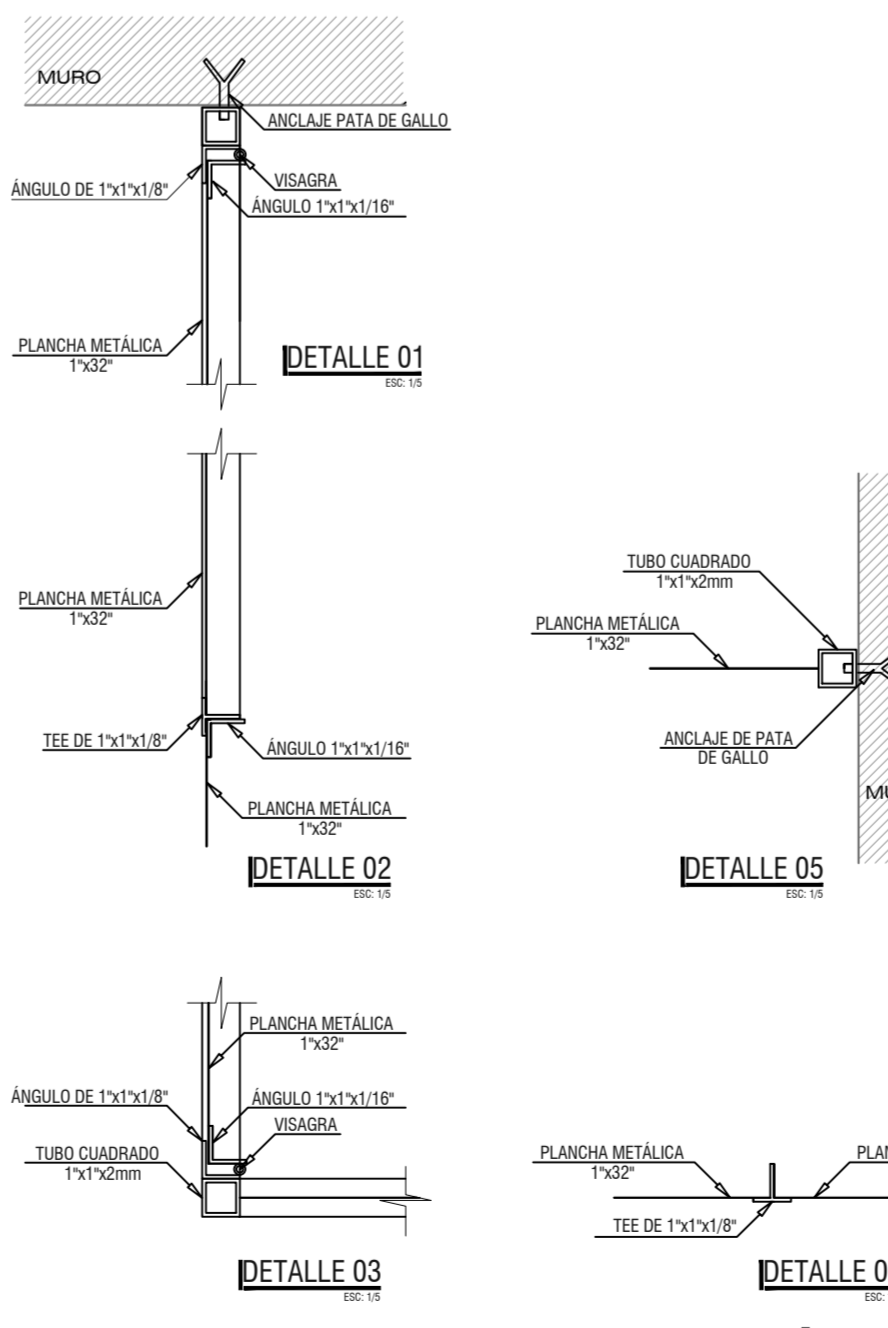

DETALLE DE ANCLAJES METALICOS ESC: 1/5

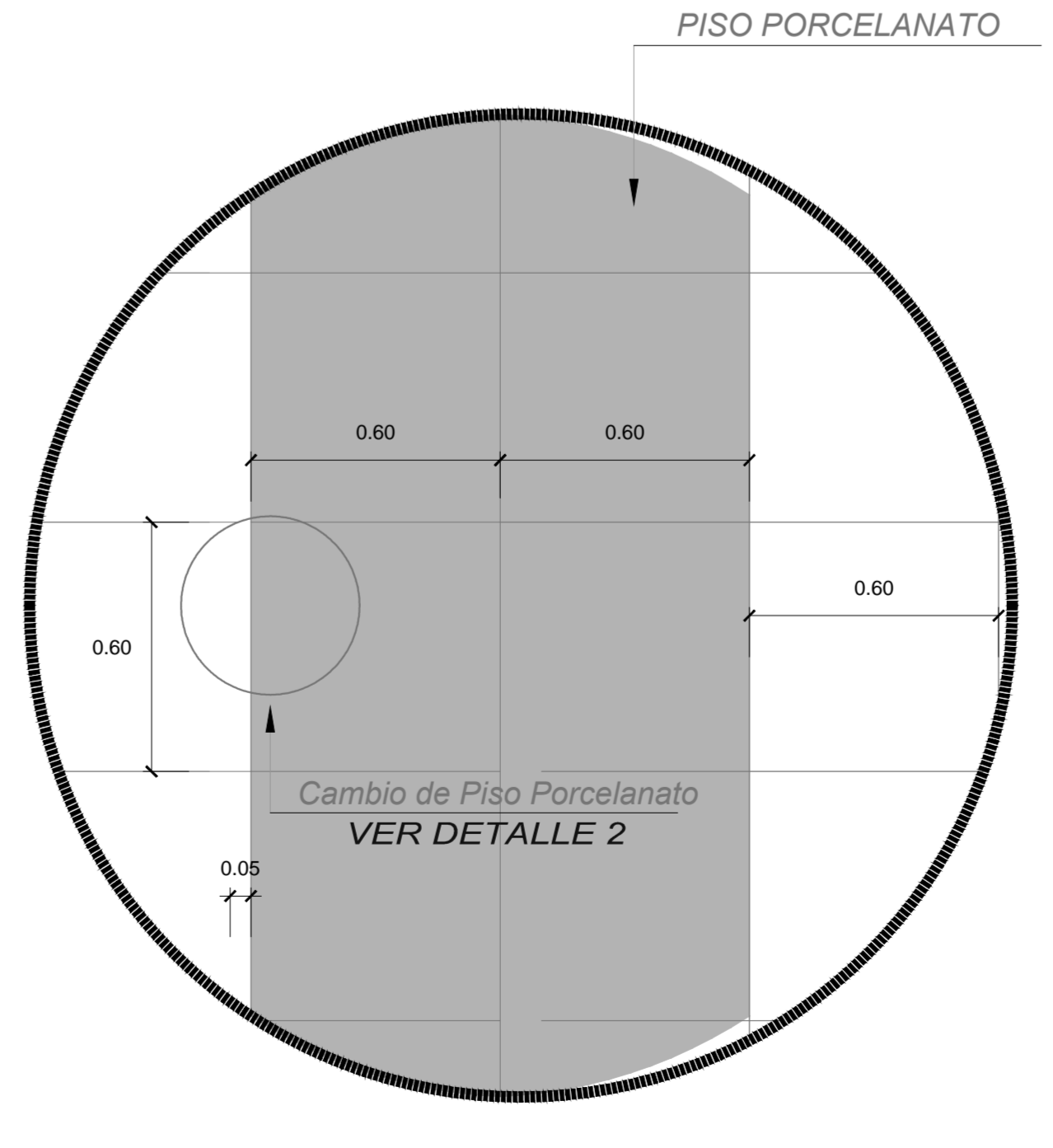

DETALLE 01 ESC: 1/5  
PISO DE PORCELANATO 0.60 x 0.60

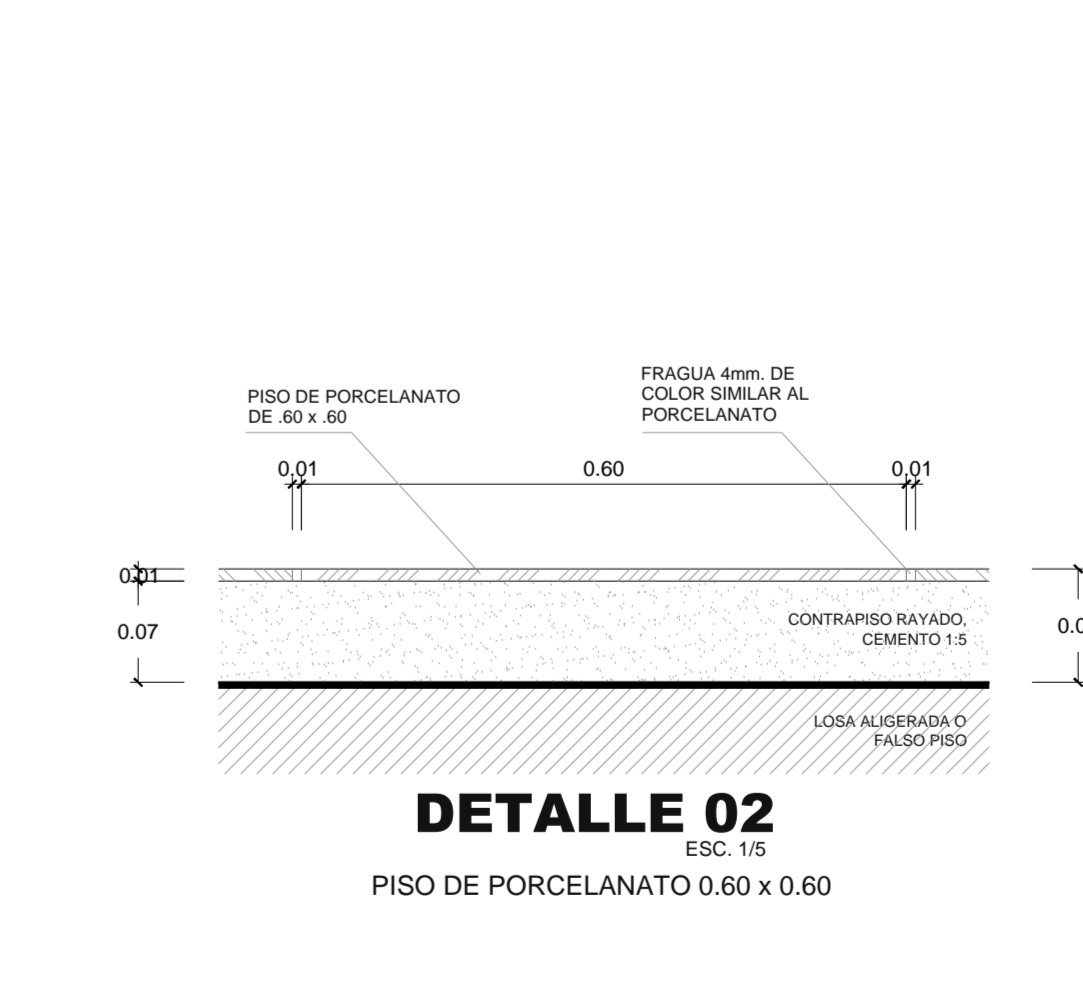

DETALLE 02 ESC: 1/5  
PISO DE PORCELANATO 0.60 x 0.60

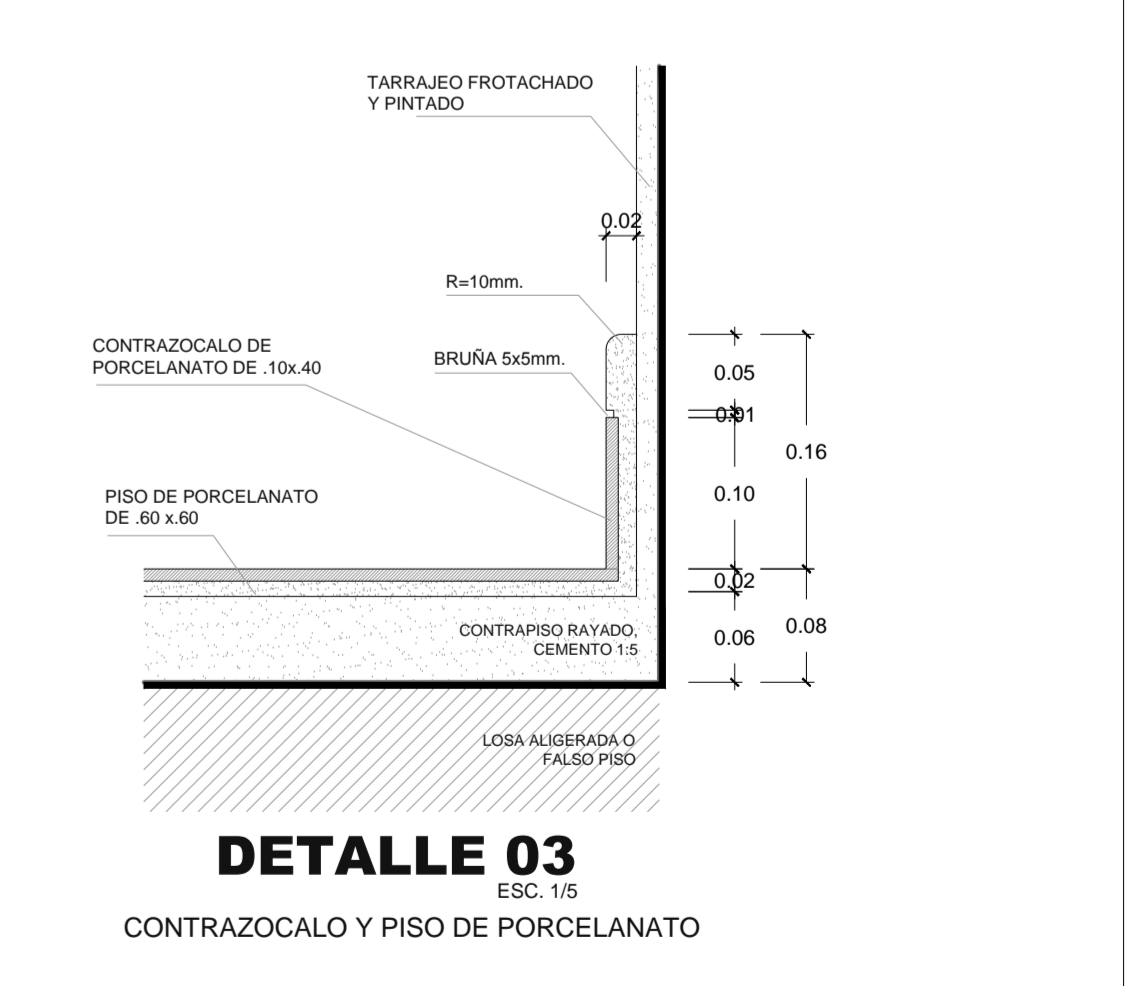

DETALLE 03 ESC: 1/5  
CONTRAZOCALO Y PISO DE PORCELANATO



### DETALLE 03 : DE CELOSIA

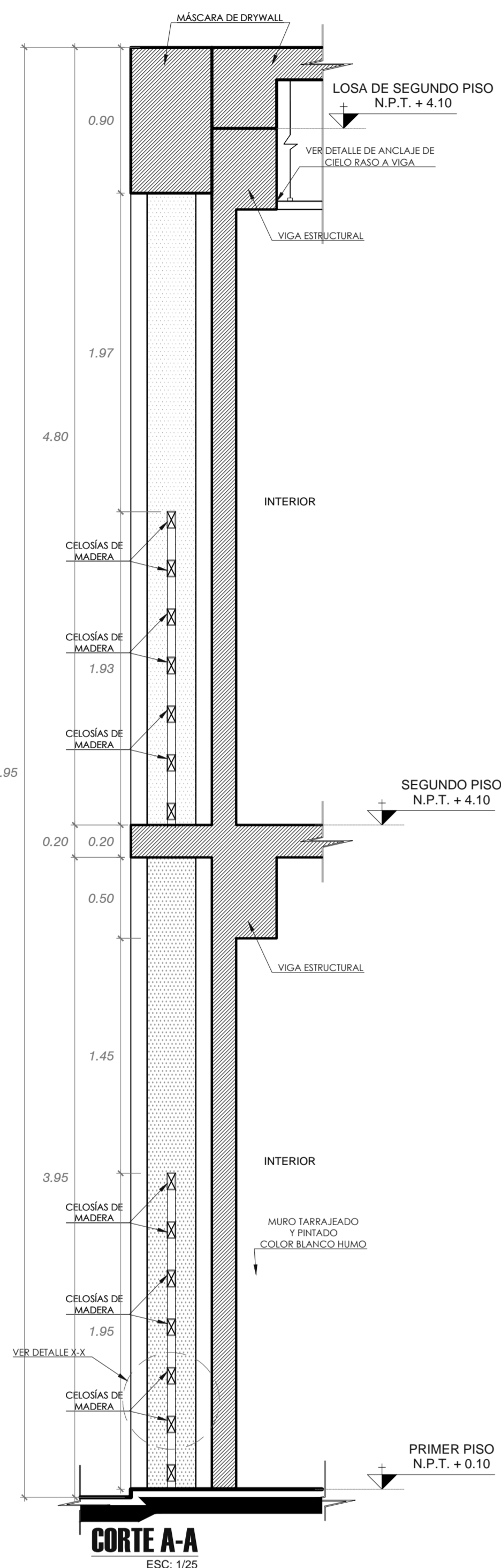
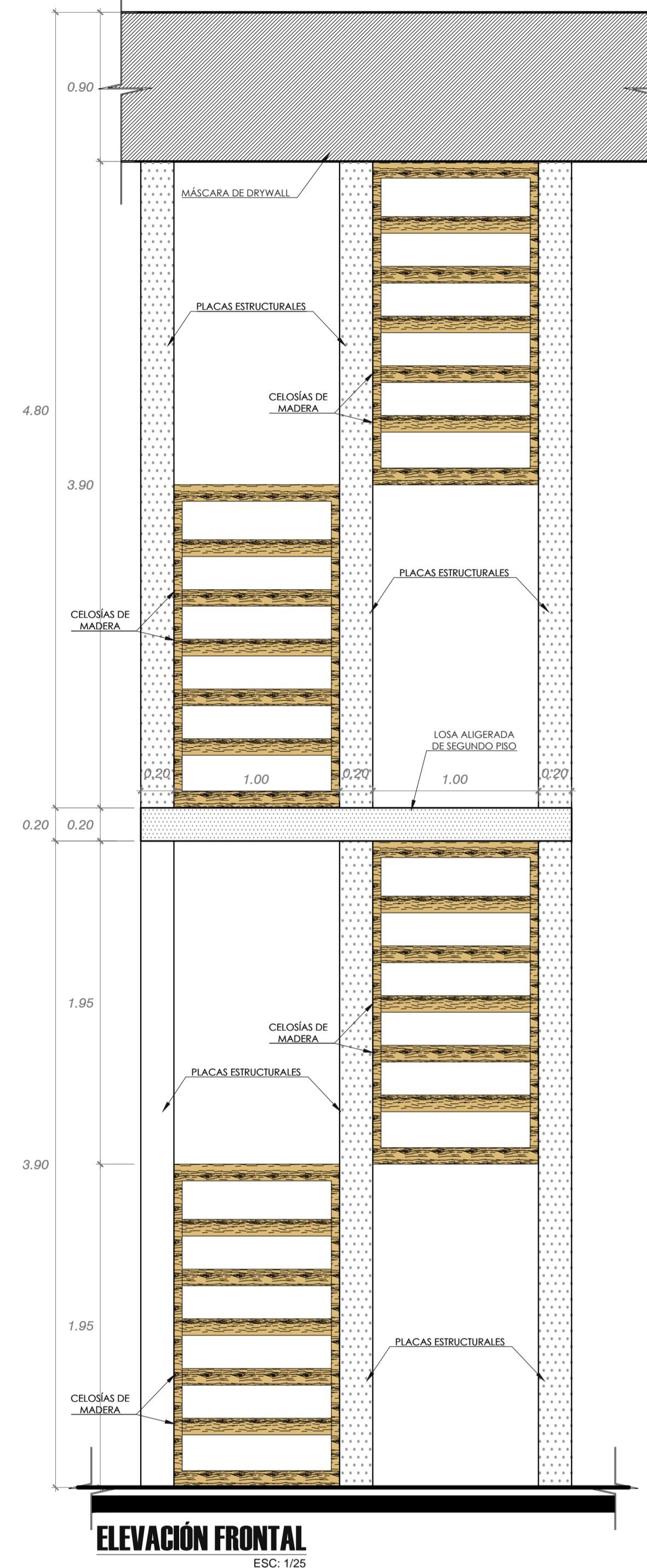
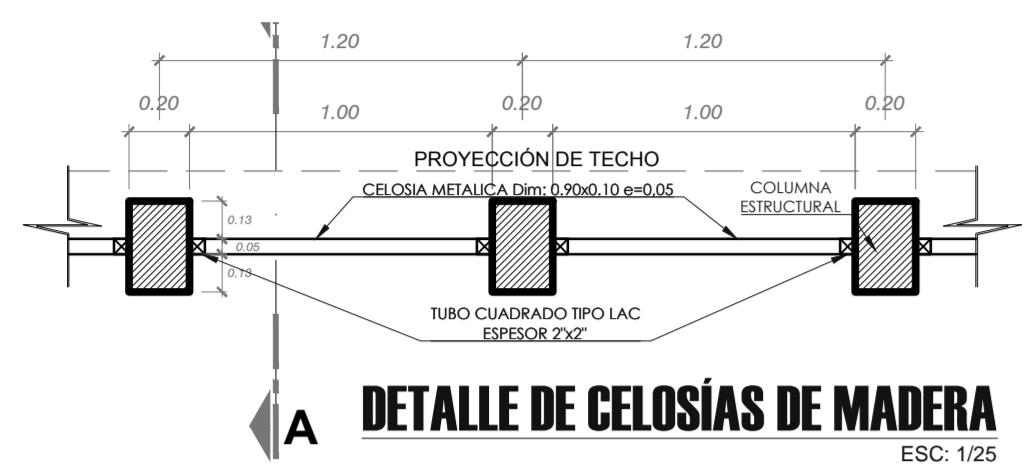

### DETALLE 01 : DE ESCALERA

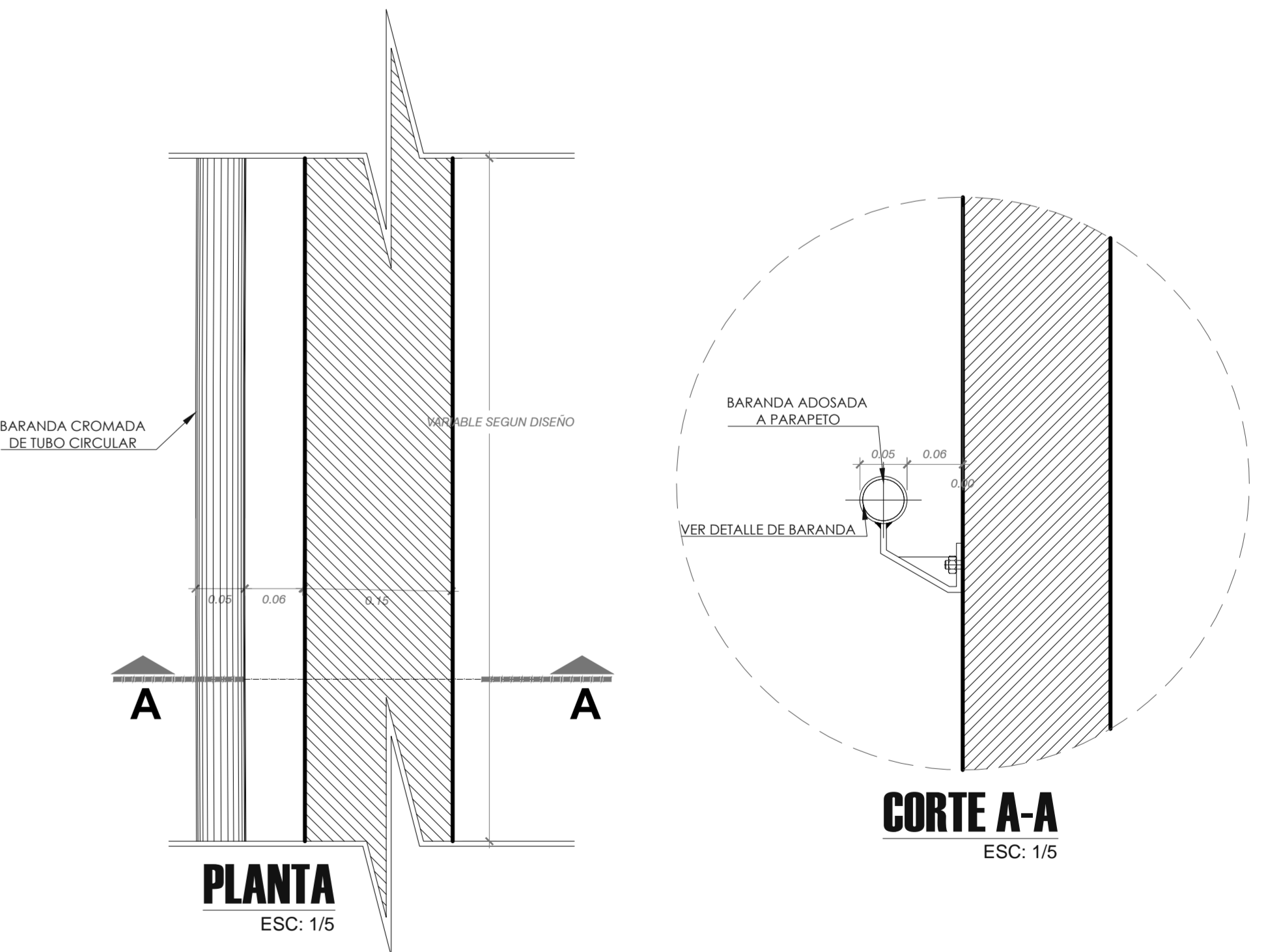
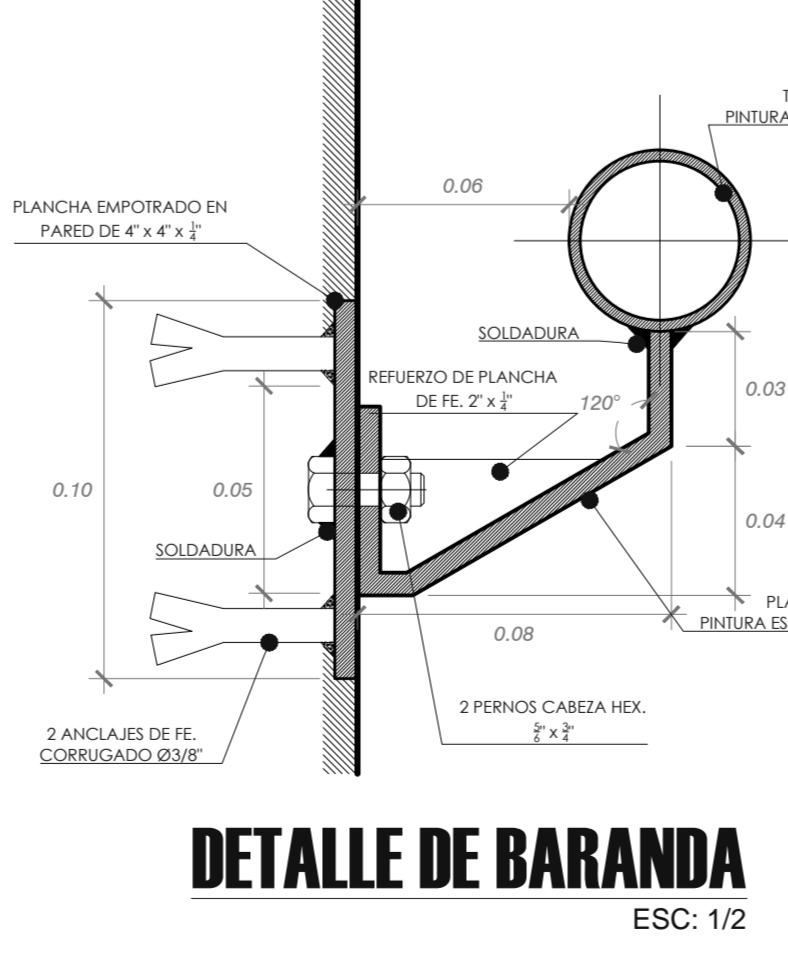
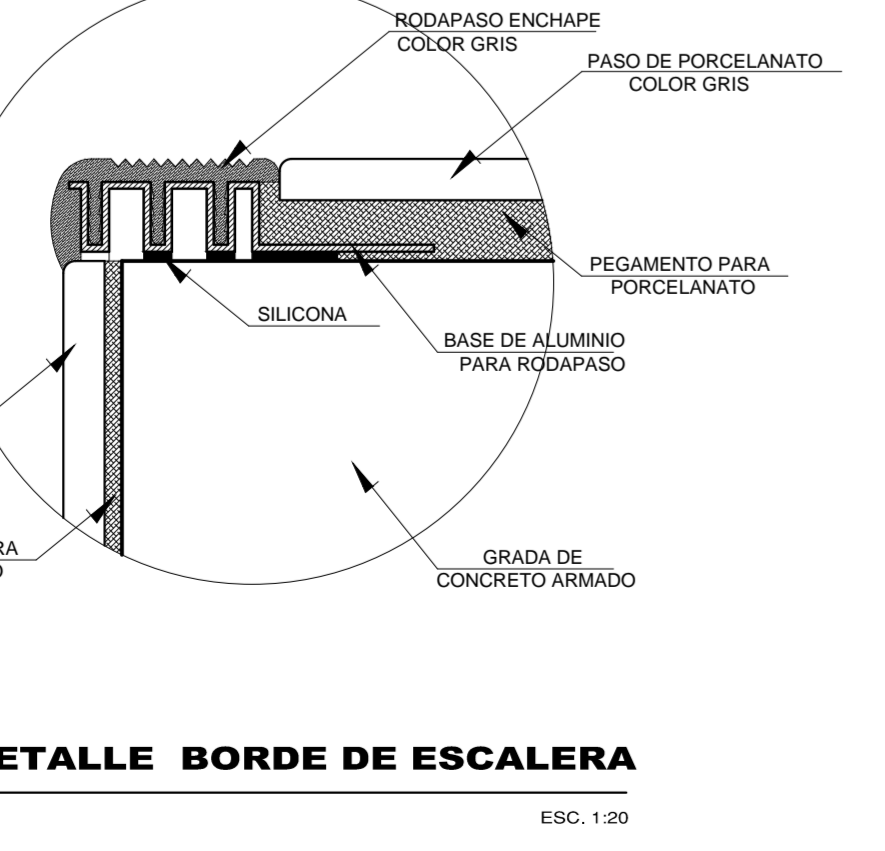
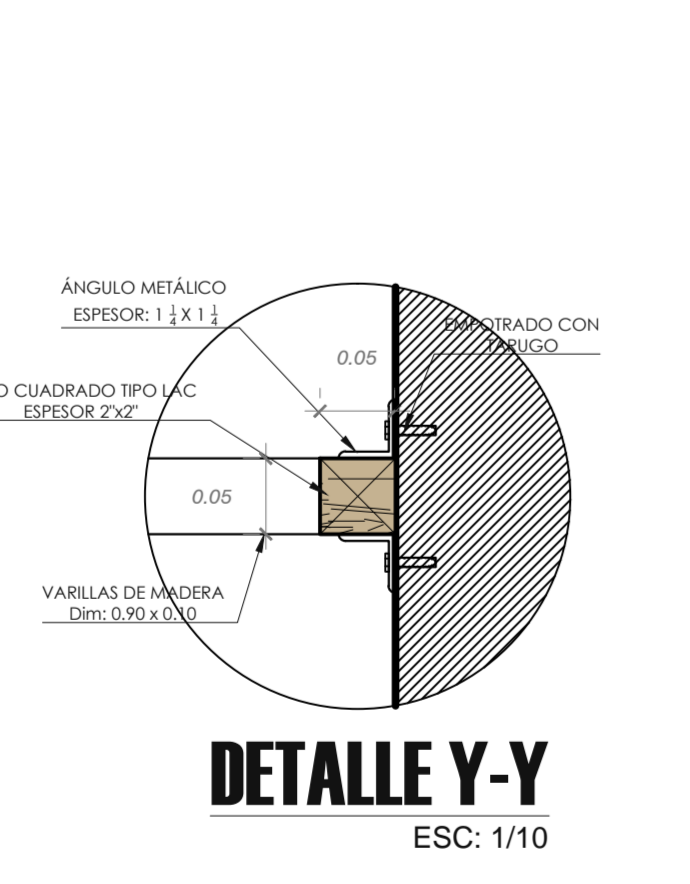
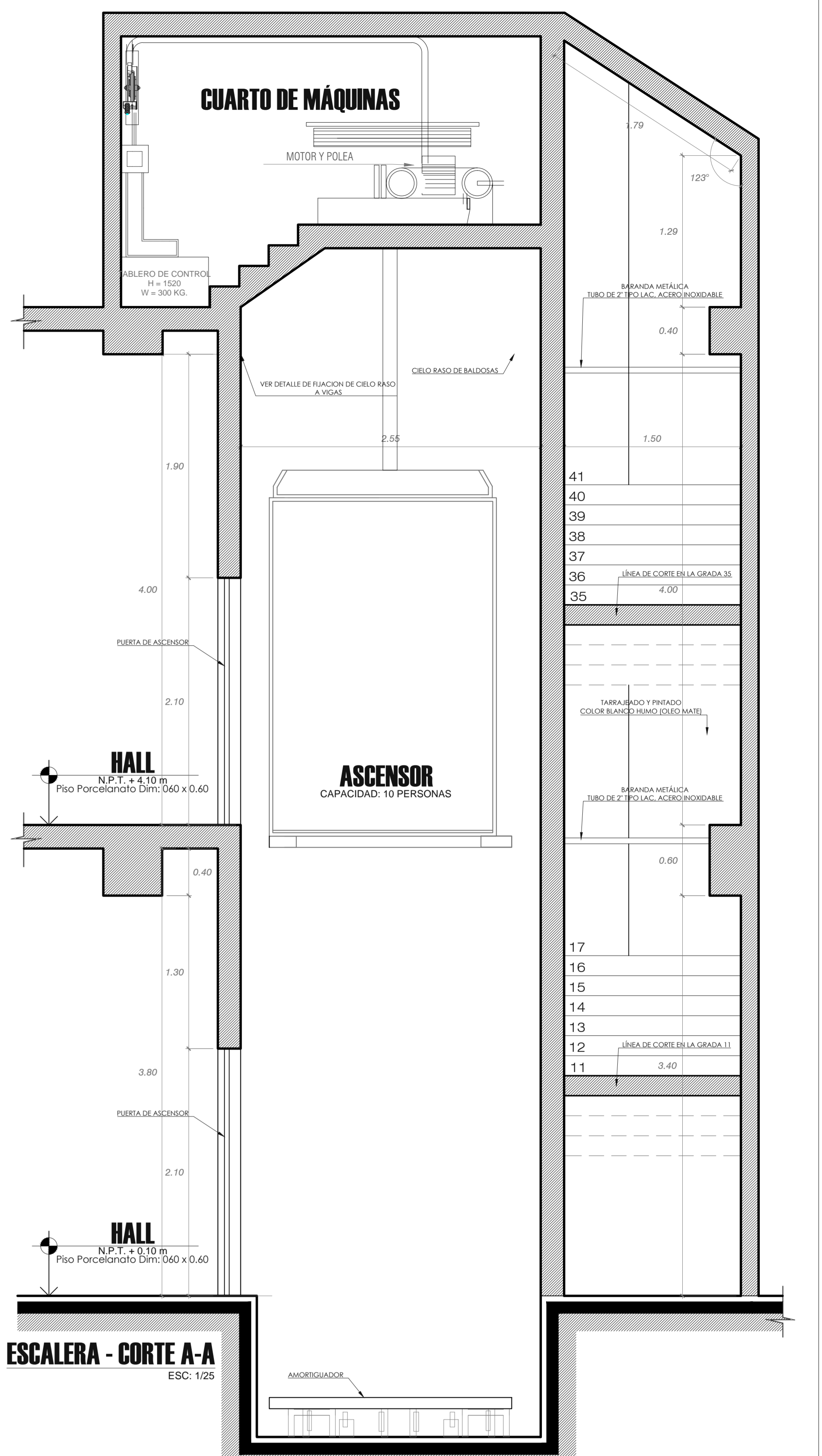
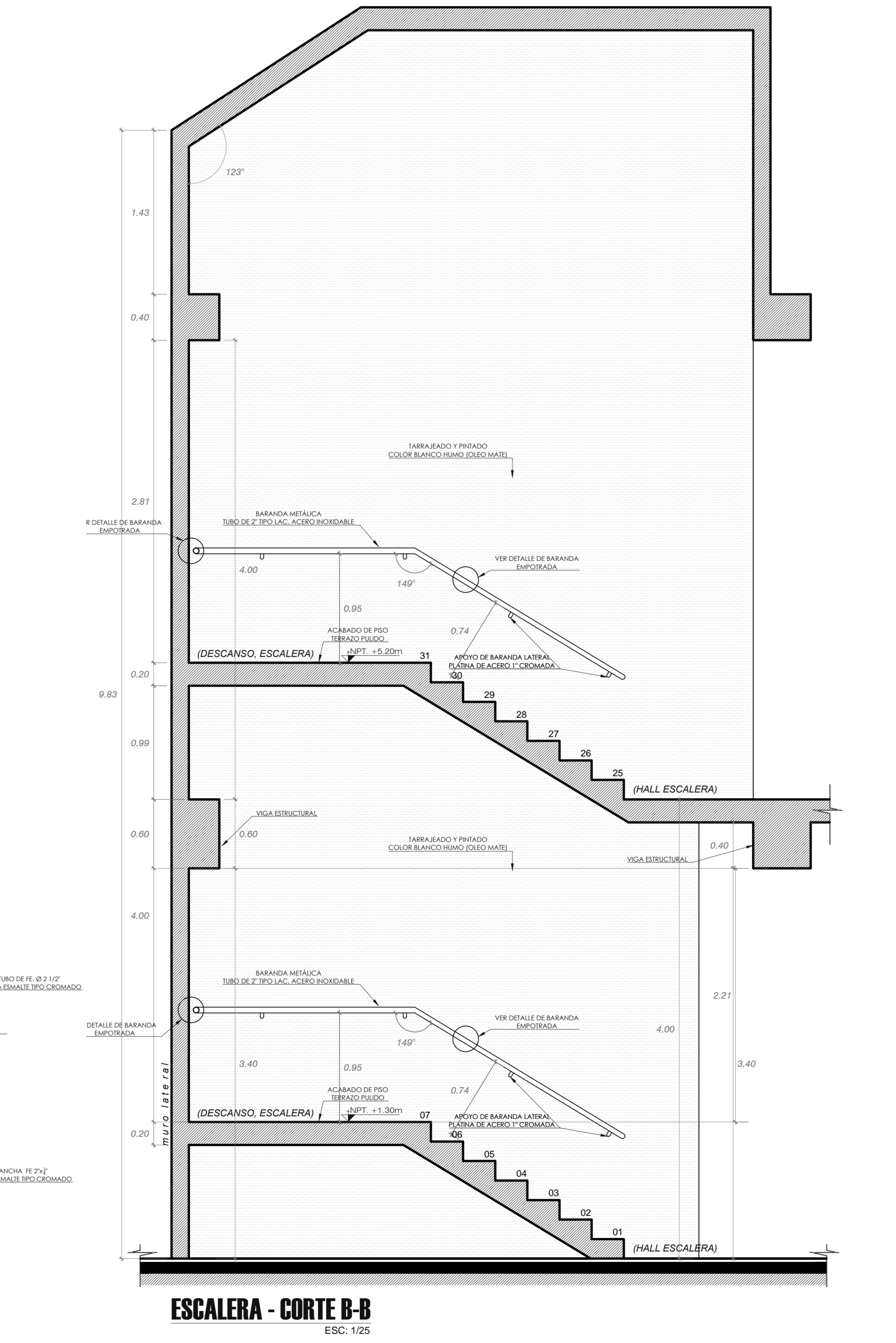
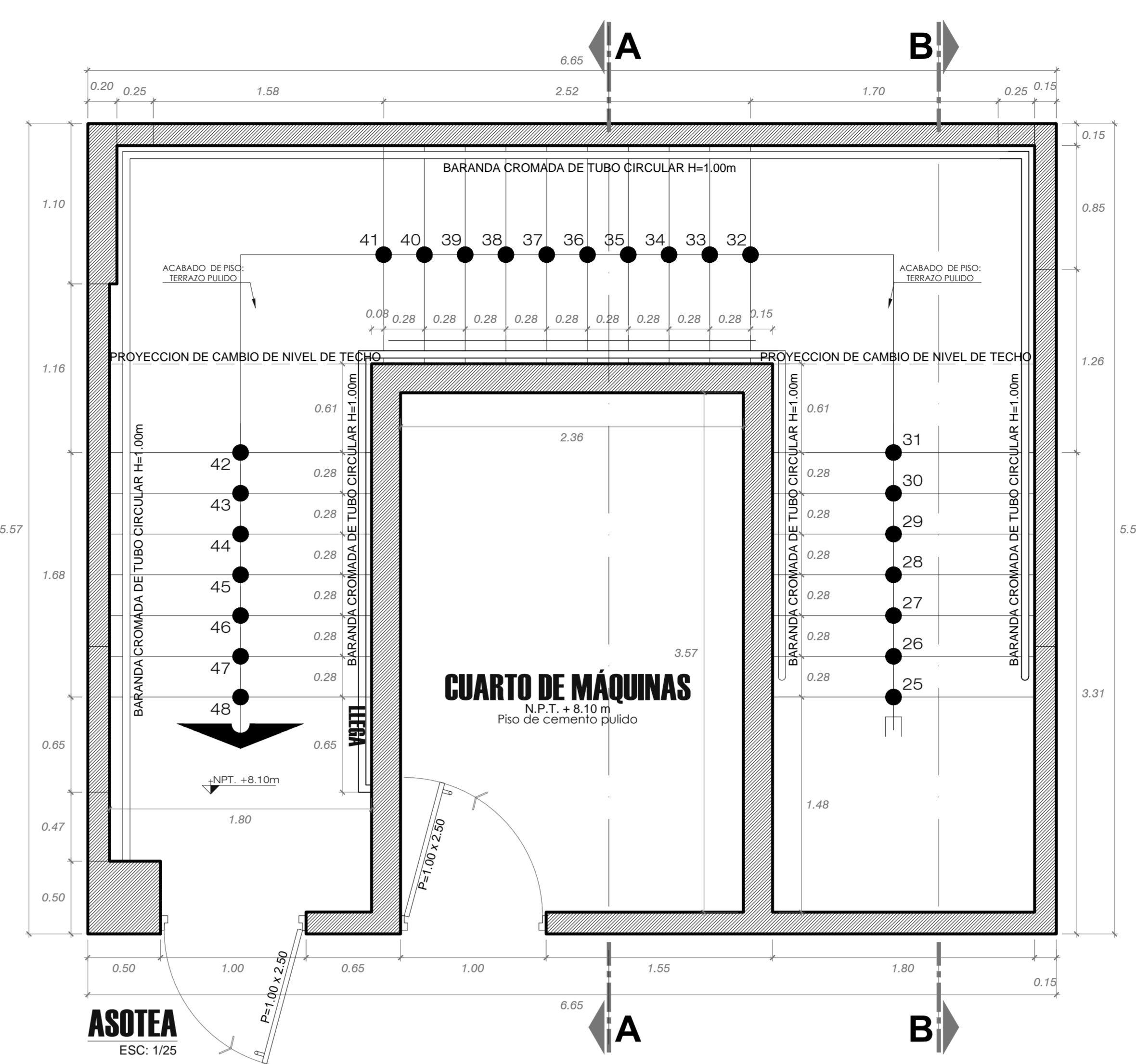
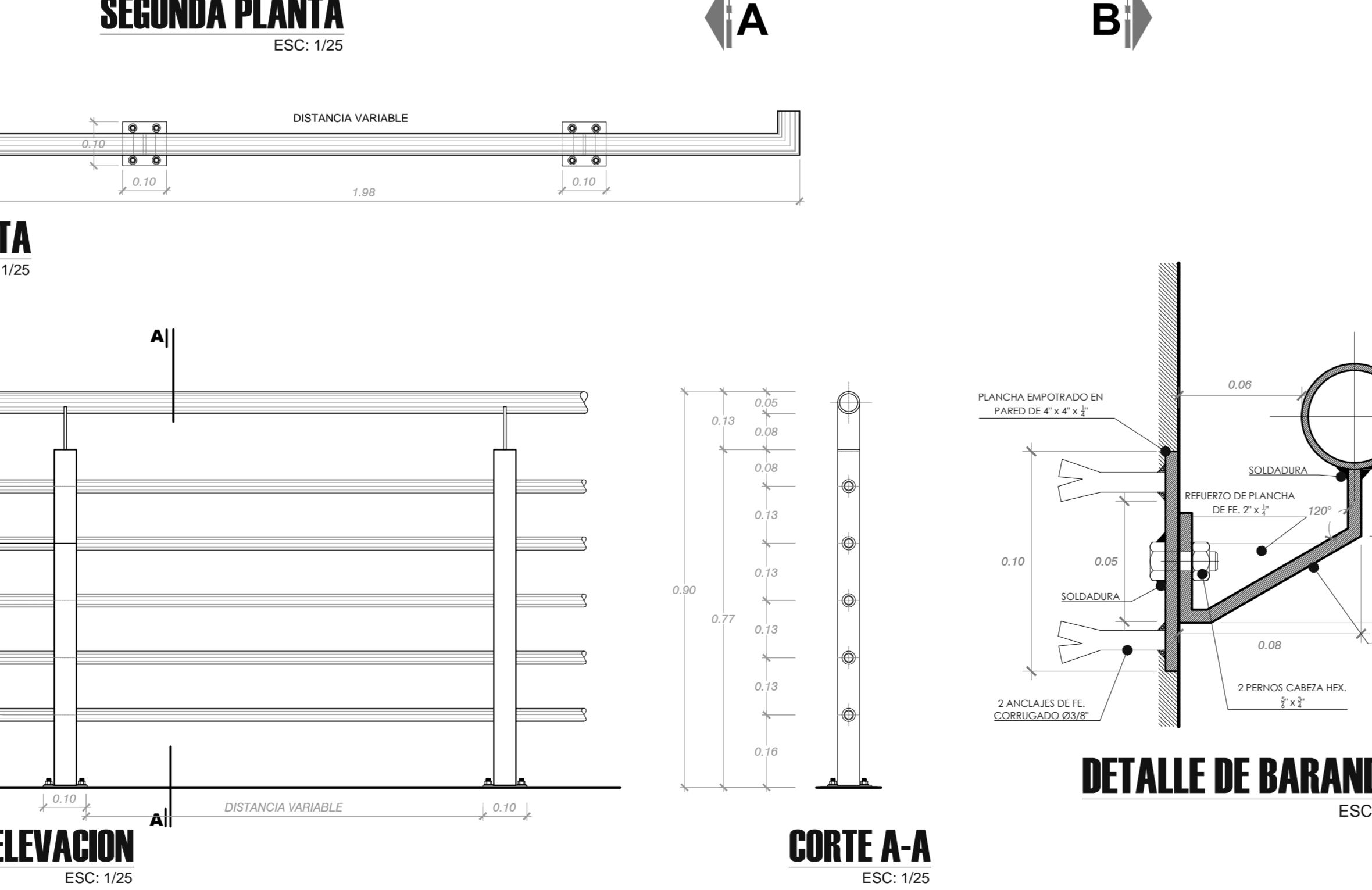
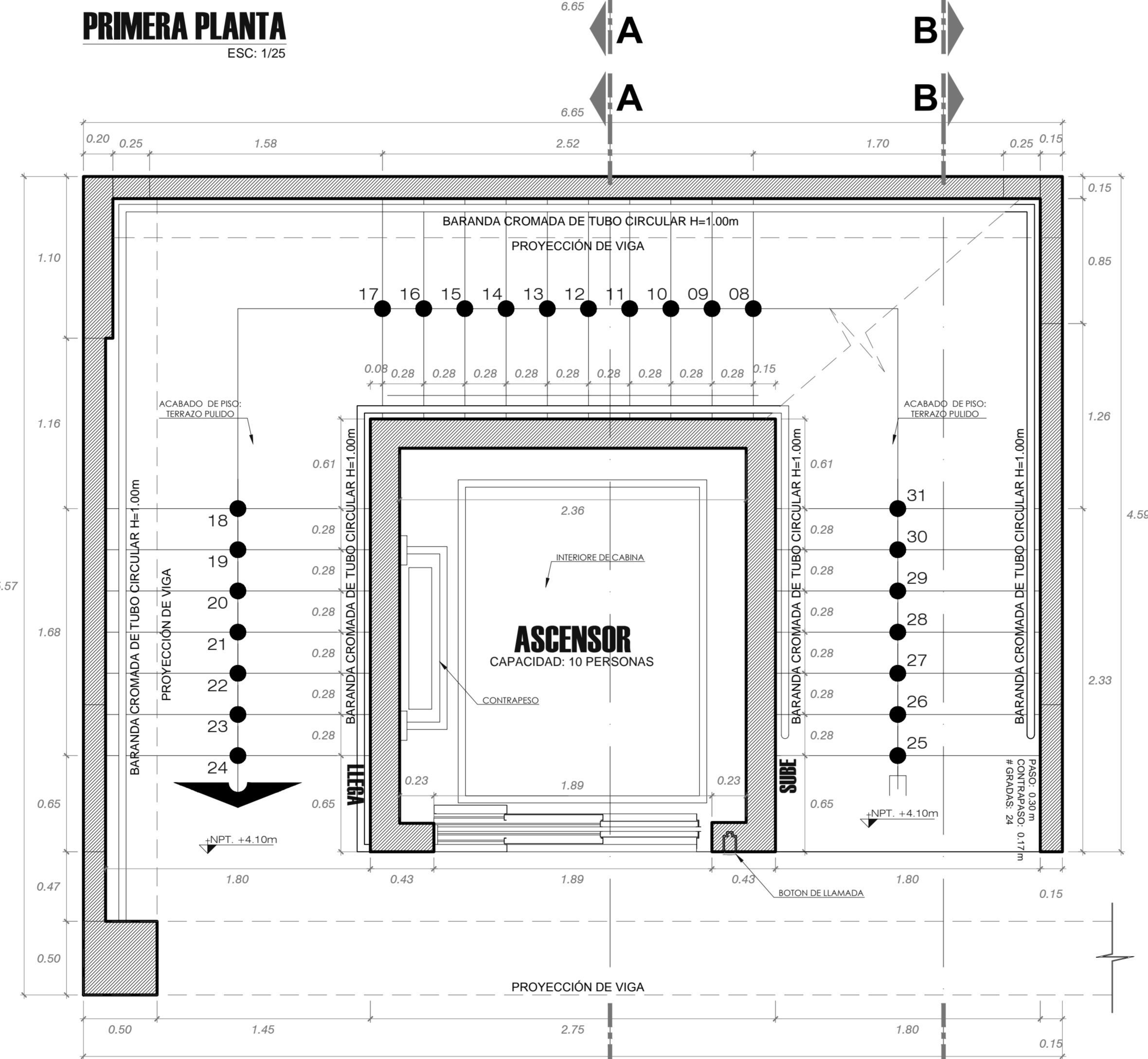
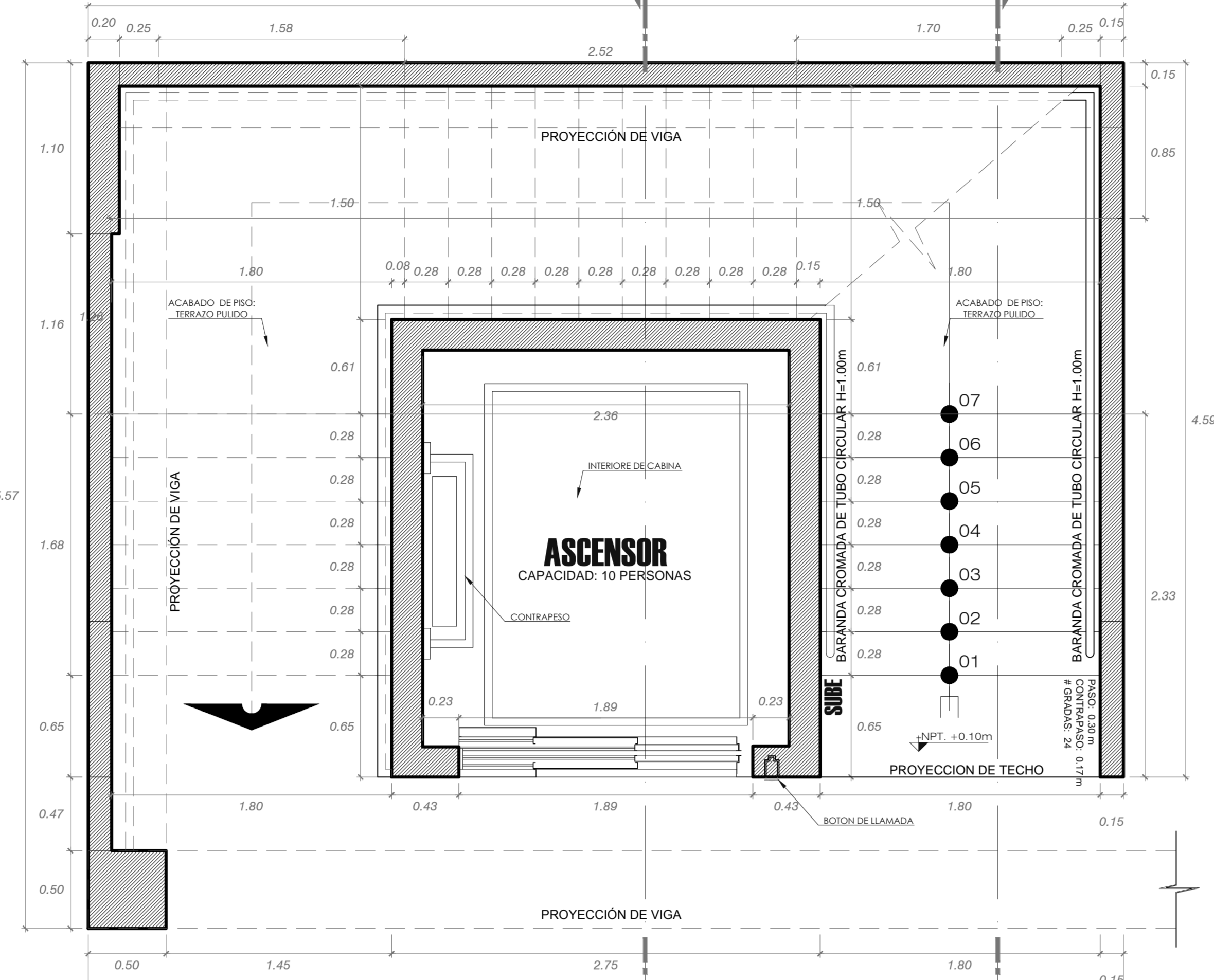

UNIVERSIDAD PRIVADA DE TACNA FACULTAD DE ARQUITECTURA Y URBANISMO	
PROYECTO: CENTRO DE ATENCION ESPECIALIZADA PARA LA REHABILITACION A PERSONAS CON DISCAPACIDAD FISICA EN LA REGION DE TACNA, 2017	
V TALLER TUTORIAL DE TESIS	
PLANO: DETALLE DE CELOSIA Y ESCALERA	
ALUMNO: ARQ. ROSA TORRES MIRANDA	TESISA: BACH. ARQ. MIGUEL ANGEL GOMEZ RODRIGUEZ
FECHA: 1/1/25	FECHA: MARZO - 2018
N° de PLANCHA: D-02	