

CORTE A-A

ARQUITECTURA **SECTOR - 2: CORTE A-A**
PROYECTO

escala 1:75

				UNIVERSIDAD PRIVADA DE TACNA FACULTAD DE ARQUITECTURA Y URBANISMO			
				PROYECTO: TERMINAL TERRESTRE			
PLANO: PLANO PROYECTO - SECTOR 2				LAMINA:			
ASESOR: ARQ. JANETH NOEMI CRUZ CHIRI		BACHILLER: ALEXIS EDDY PONGO COPA		UBICACION: DISTRITO ALTO DE LA ALIANZA			
CURSO: VIII - TALLER TUTORIAL DE TESIS		LUGAR: TACNA - PERU		FECHA: 28/09/2020			
				AR-09			

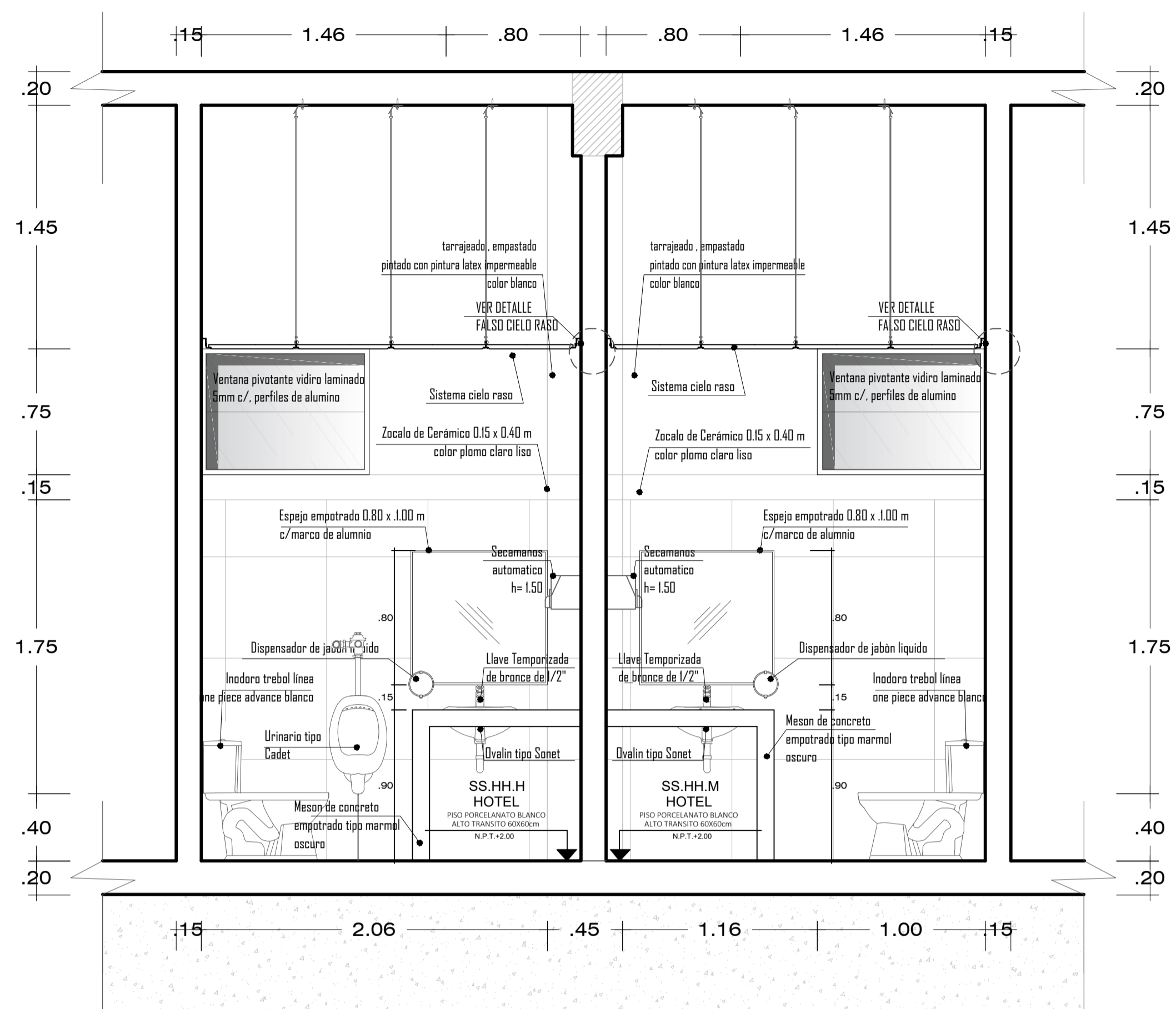

CORTE B-B VARON - DAMAS
ESC. 1/25

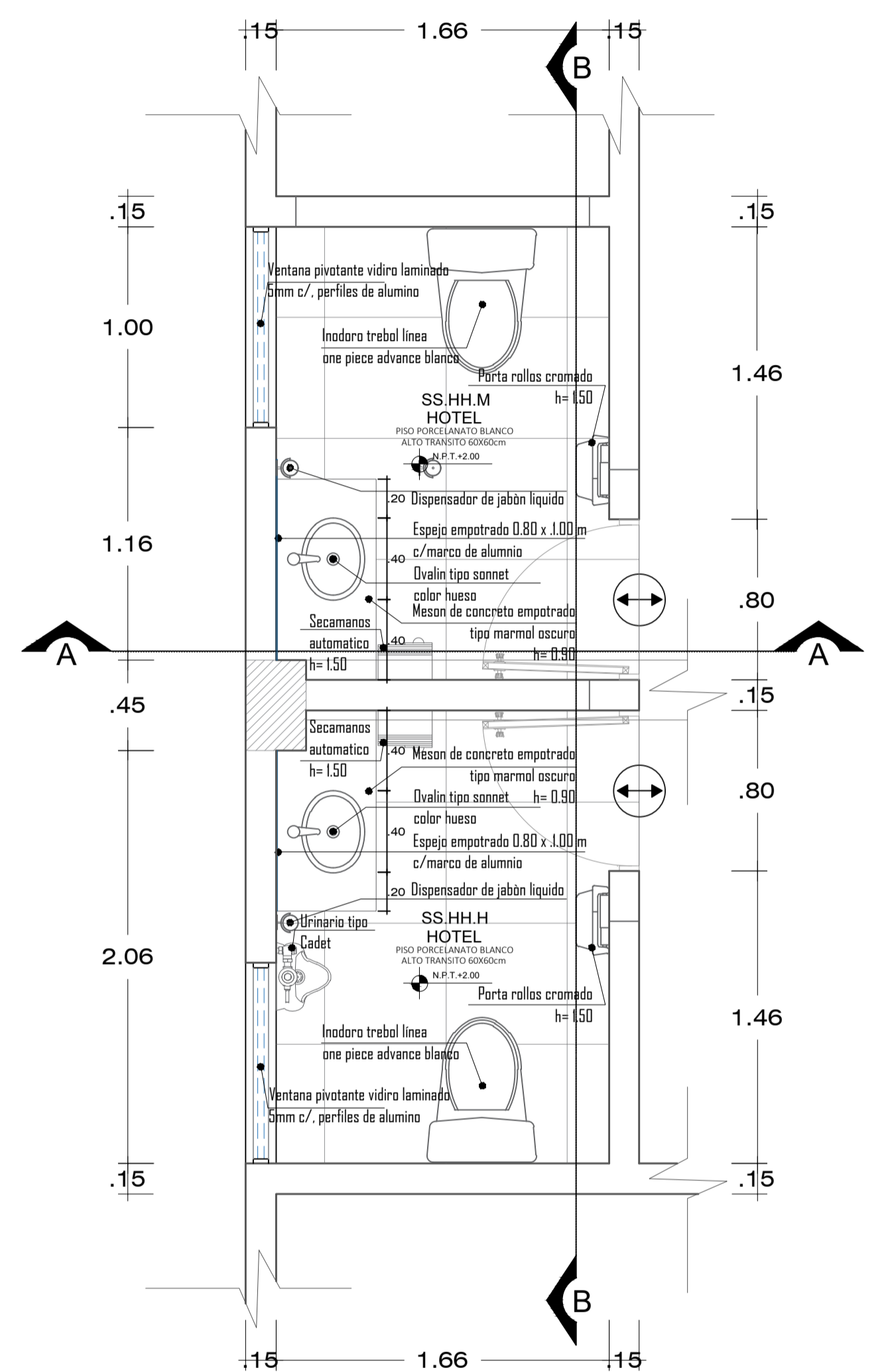

PLANO BAÑO HOTEL
ESC. 1/25

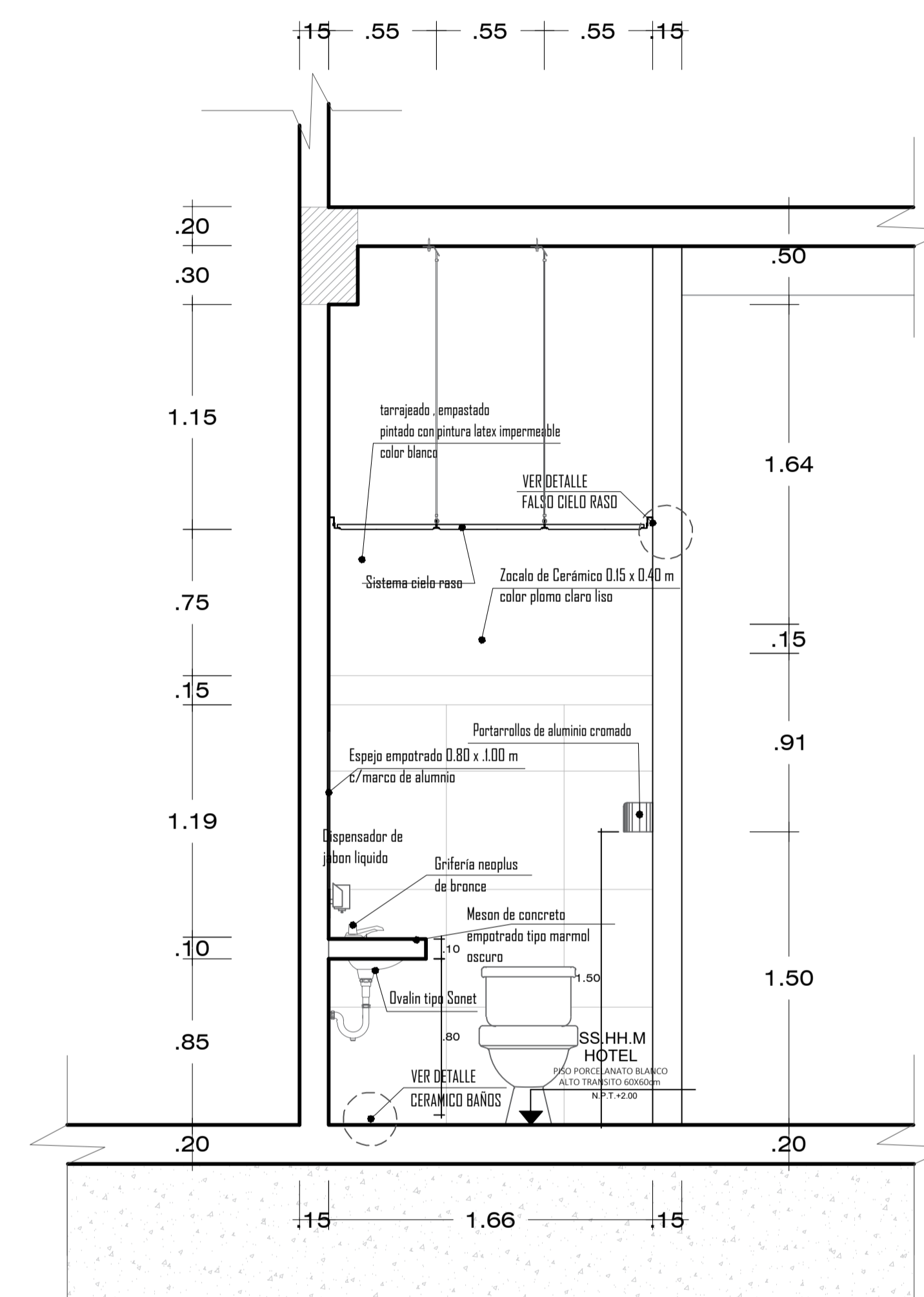

CORTE A-A DAMAS
ESC. 1/25

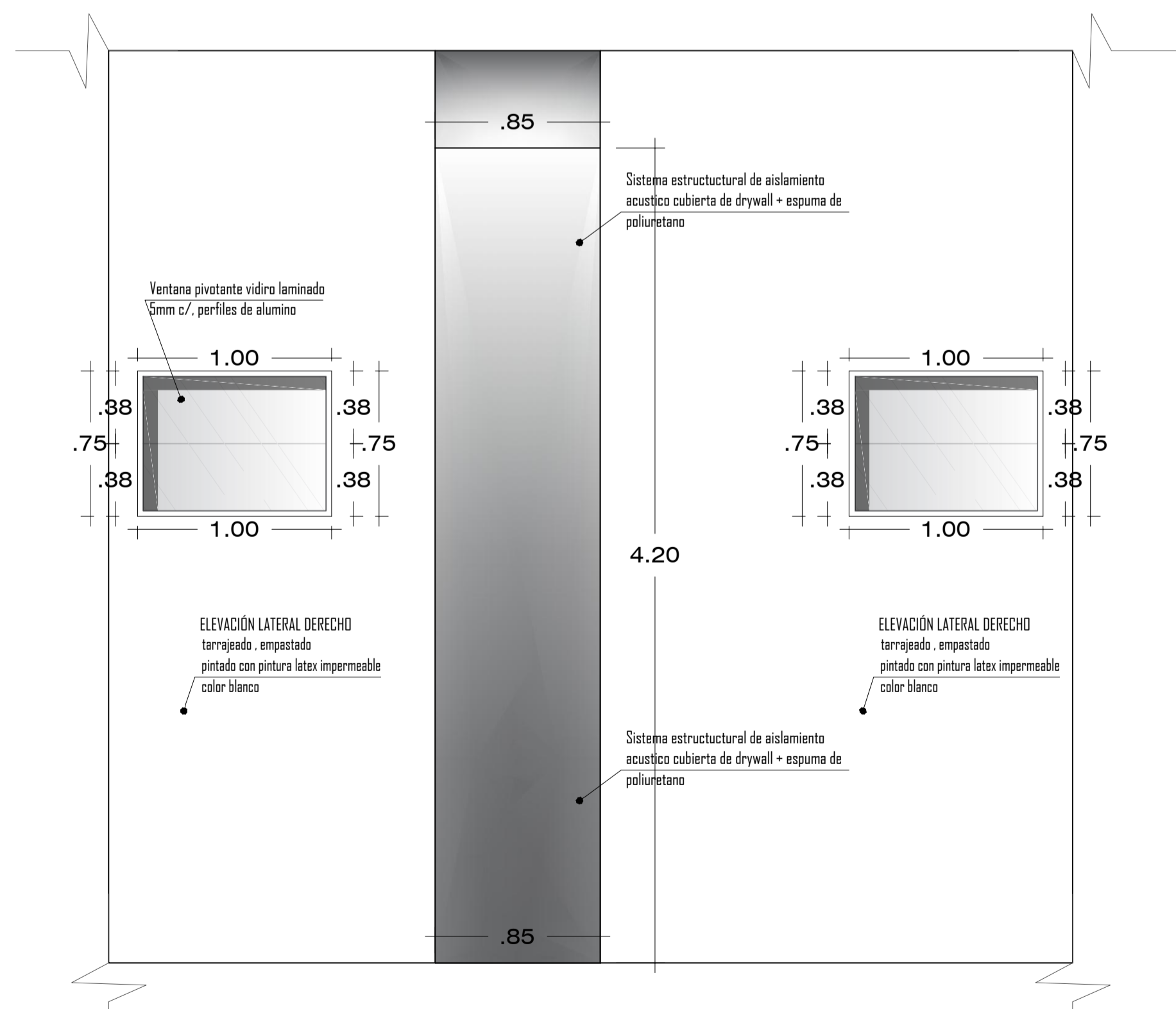

SECTOR - 1: PRIMER NIVEL
PLANO DE DETALLES

 UNIVERSIDAD PRIVADA DE TACNA FACULTAD DE ARQUITECTURA Y URBANISMO			
PROYECTO:		TERMINAL TERRESTRE	
PLANO:		PLANO DE DETALLES - SECTOR 1	
ASESOR:	BACHILLER:	UBICACIÓN:	LAMINA:
ARQ. JANETH NOEMI CRUZ CHIRI	ALEXIS EDDY PONGO COPA	DISTRITO ALTO DE LA ALIANZA	DE-01
CURSO:		LUGAR:	FECHA:
VIII - TALLER TUTORIAL DE TESIS		TACNA - PERÚ	28/09/2020
ESCALA:		1/25	

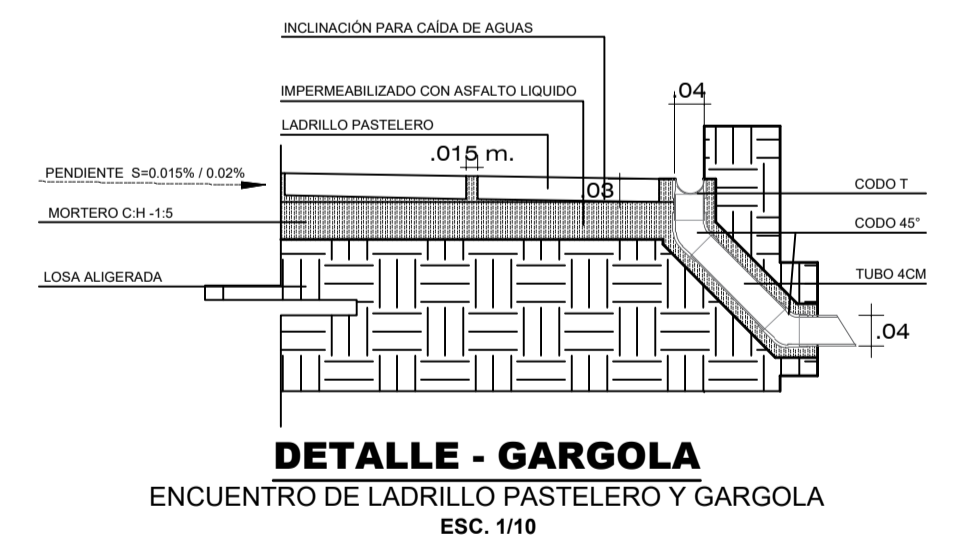
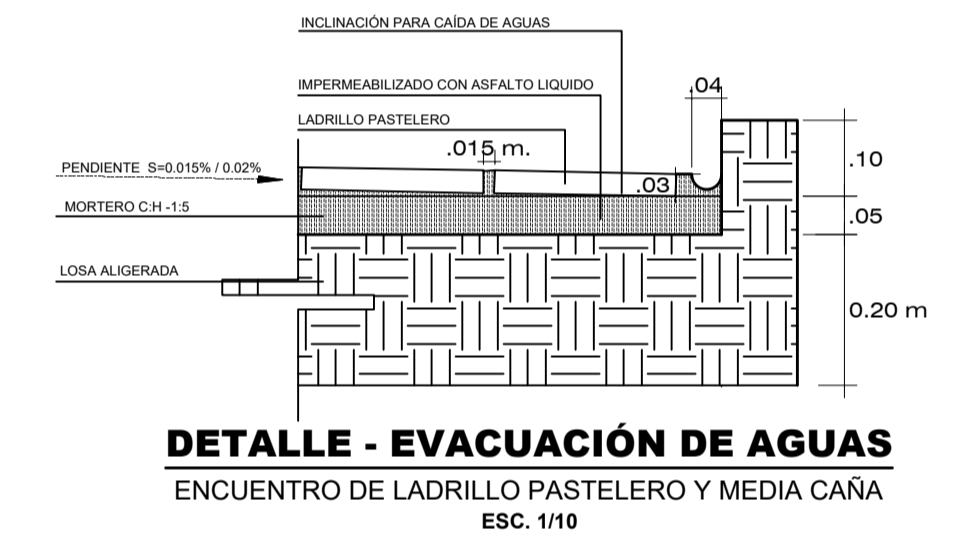
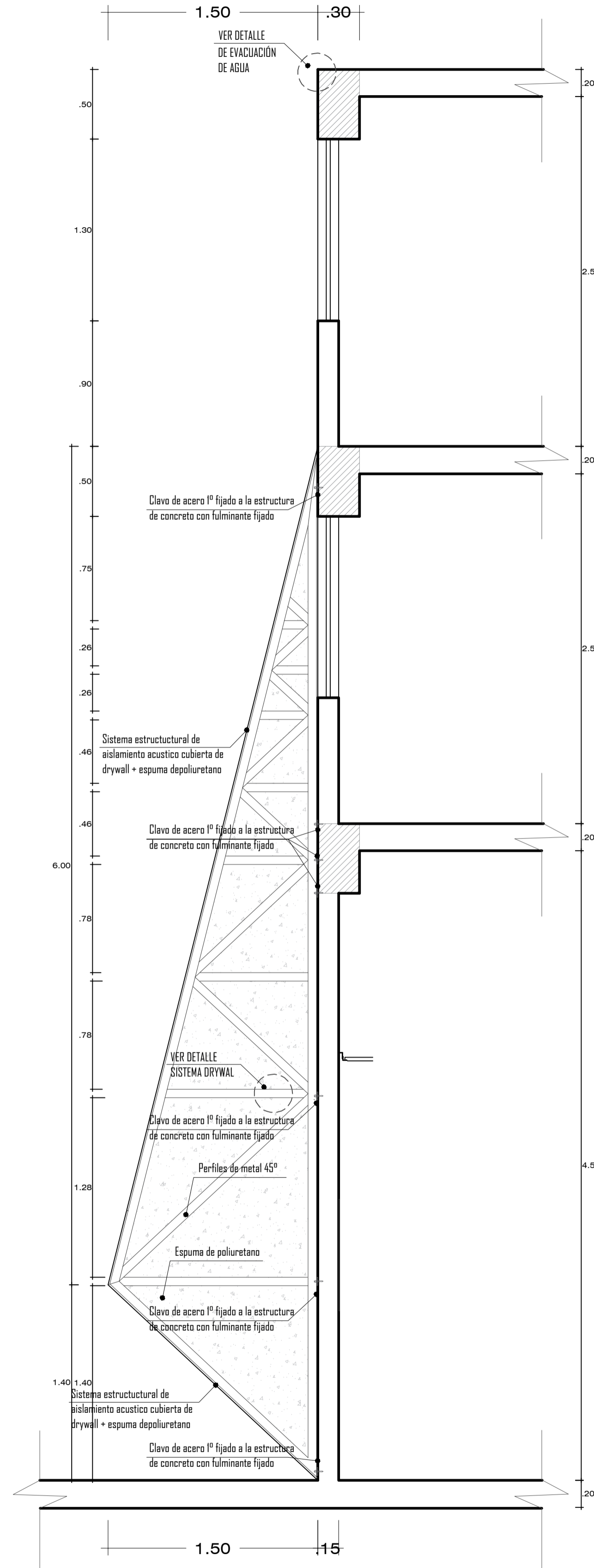
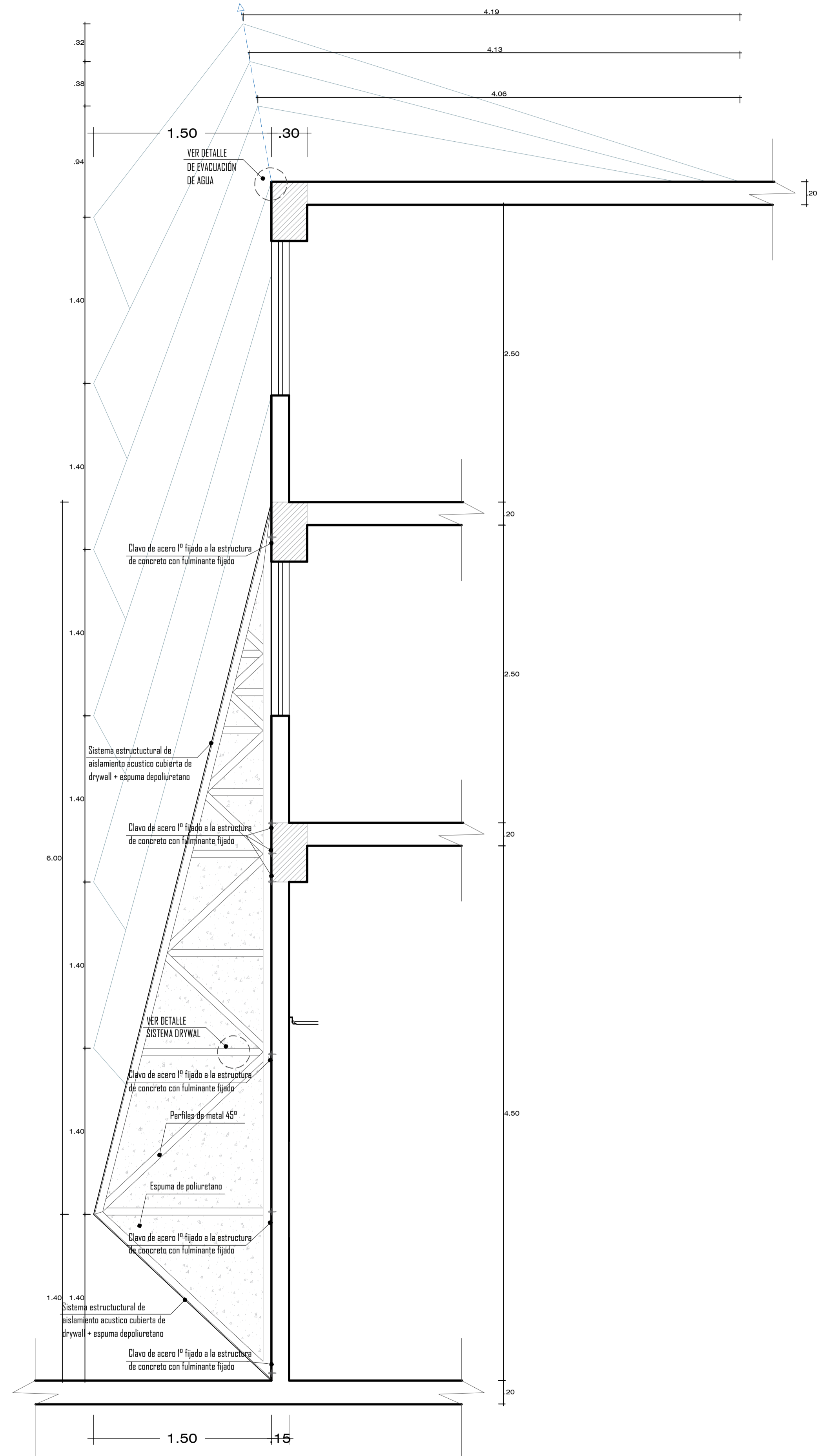

SECCION DE AISLAMIENTO ACUSTICO
ESC. 1/25

				UNIVERSIDAD PRIVADA DE TACNA FACULTAD DE ARQUITECTURA Y URBANISMO	
PROYECTO:		TERMINAL TERRESTRE			
PLANO:		PLANO DE DETALLES - SECTOR 1			ESCALA: 1/25
ASESOR:	BACHILLER:	ALEXIS EDDY PONGO COPA	UBICACIÓN:	DISTRITO ALTO DE LA ALIANZA	
ARQ. JANETH NOEMI CRUZ CHIRI	CURSO:	VIII - TALLER TUTORIAL DE TESIS	LUGAR:	TACNA - PERÚ	FECHA: 28/09/2020
					DE-02

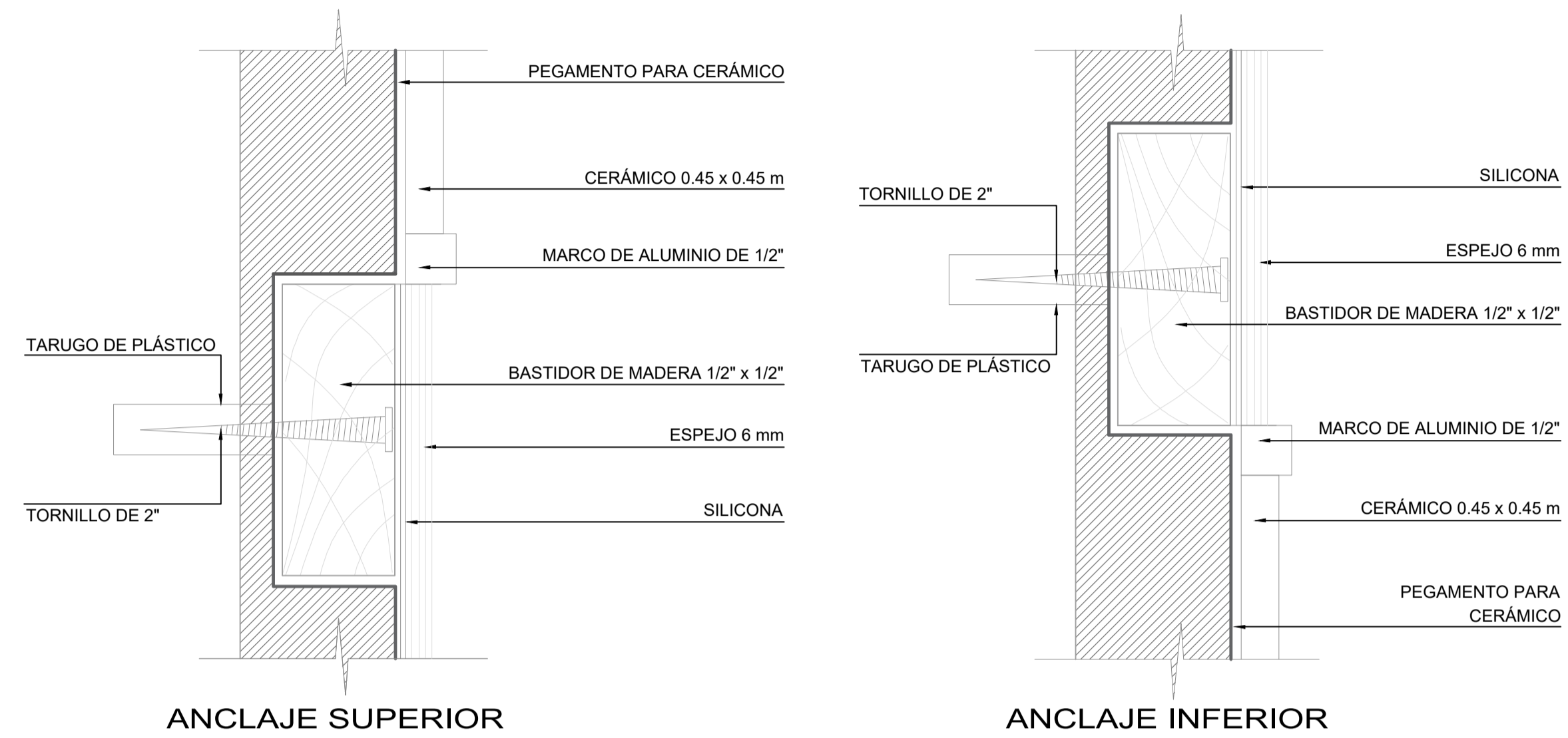

DETALLE DE FIJACION DE ESPEJO
ESC. 1/5

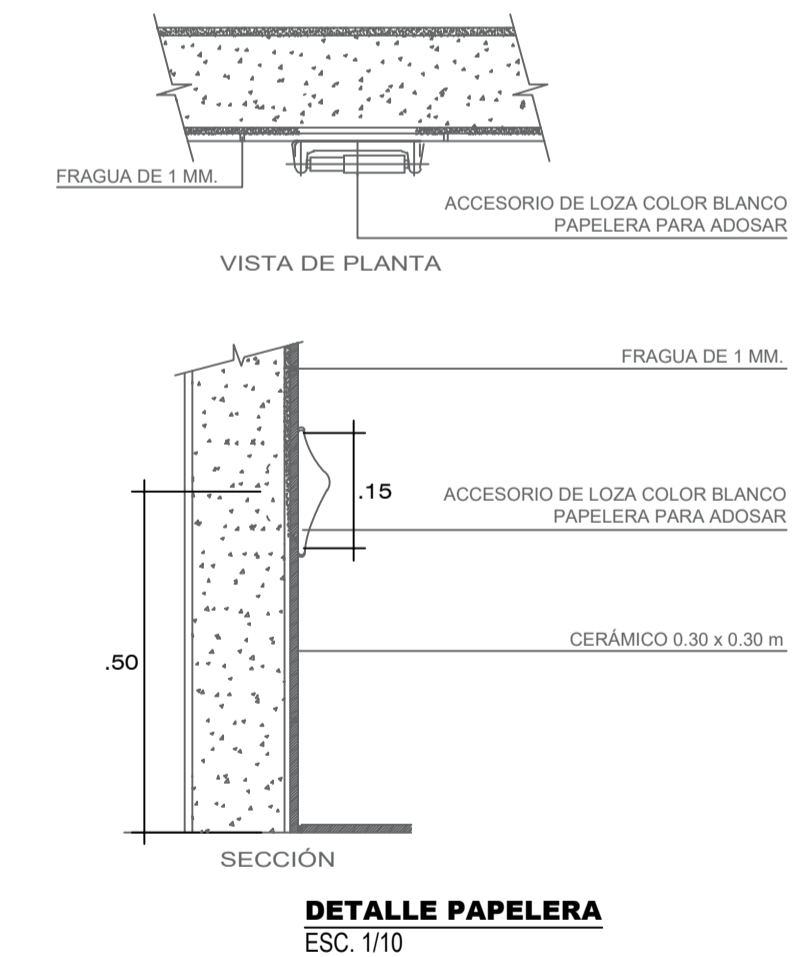
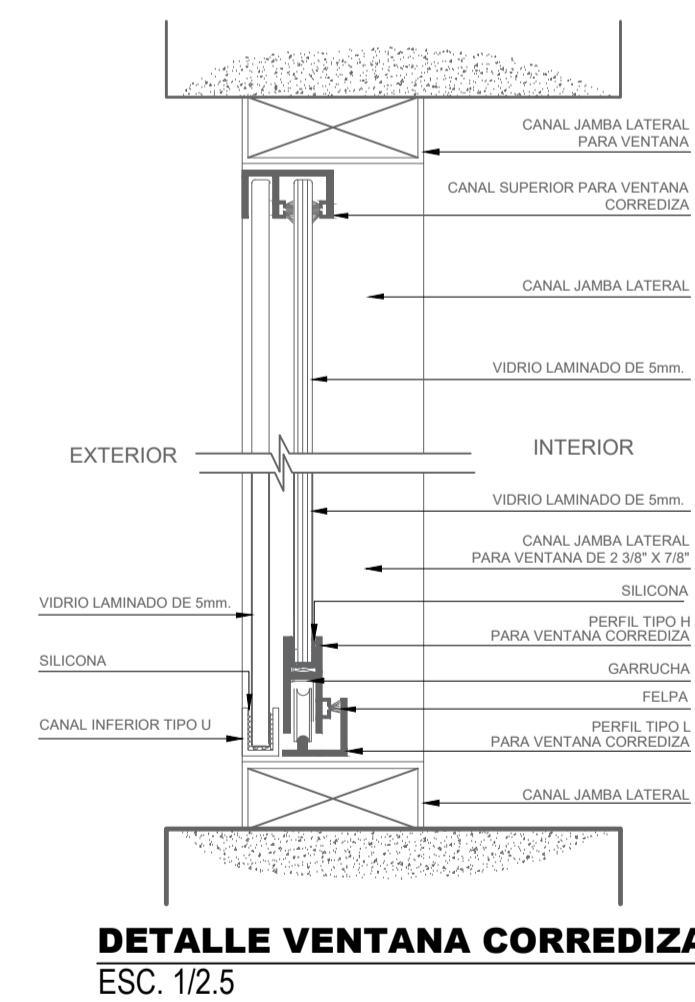
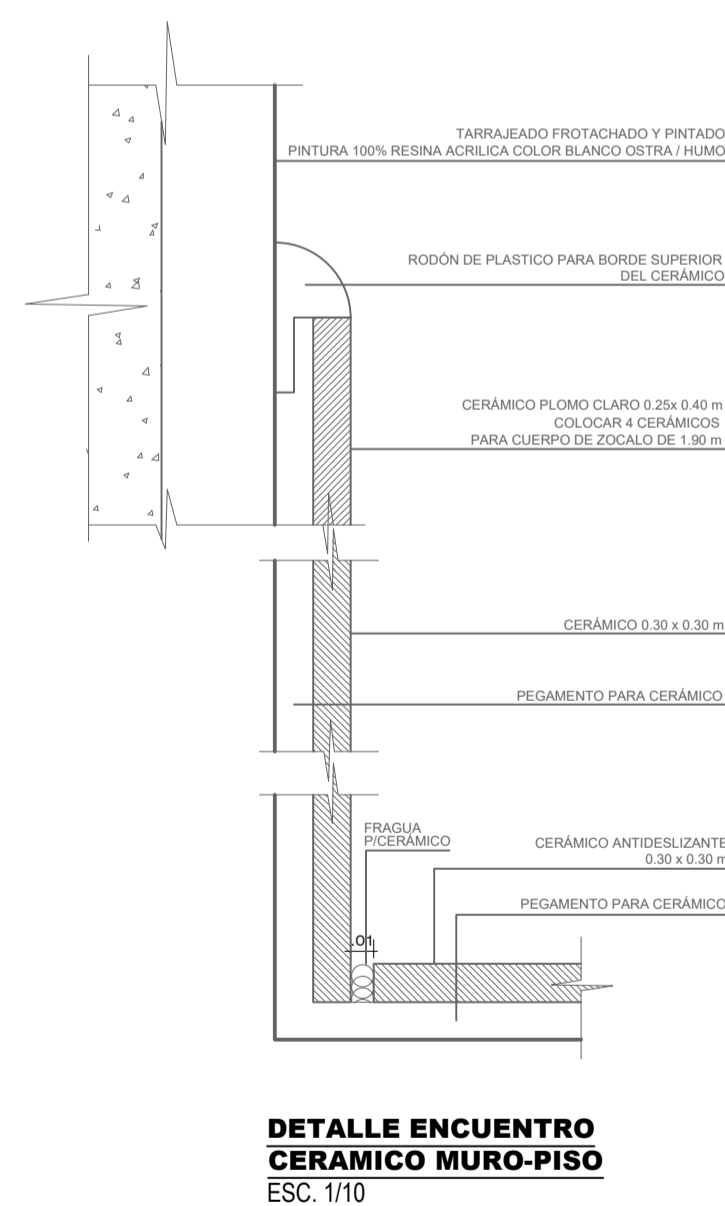
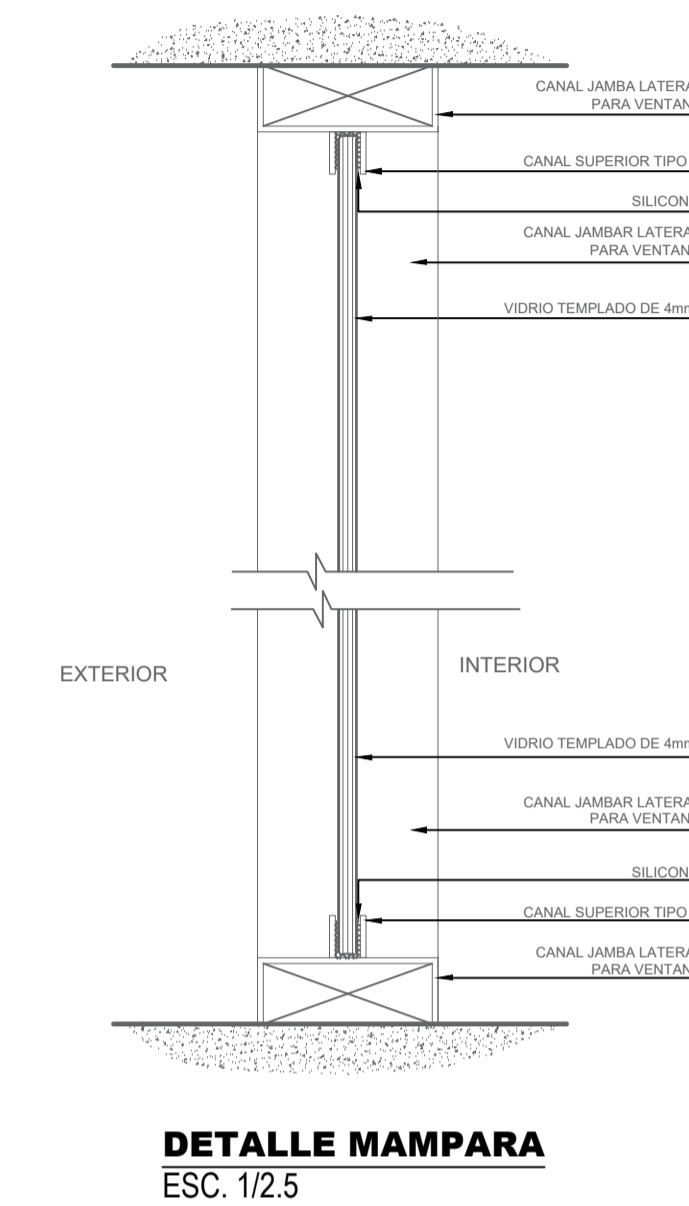

	UNIVERSIDAD PRIVADA DE TACNA FACULTAD DE ARQUITECTURA Y URBANISMO		
	PROYECTO: TERMINAL TERRESTRE		
PLANO:	PLANO PROYECTO - SECTOR 2 - PRIMER NIVEL		ESCALA: 1/25
ASESOR:	BACHILLER: ALEXIS EDDY PONGO COPA	UBICACIÓN: DISTRITO ALTO DE LA ALIANZA	LAMINA: DE-03
ARQ. JANETH NOEMI CRUZ CHIRI	CURSO: VIII - TALLER TUTORIAL DE TESIS	LUGAR: TACNA - PERÚ	FECHA: 28/09/2020

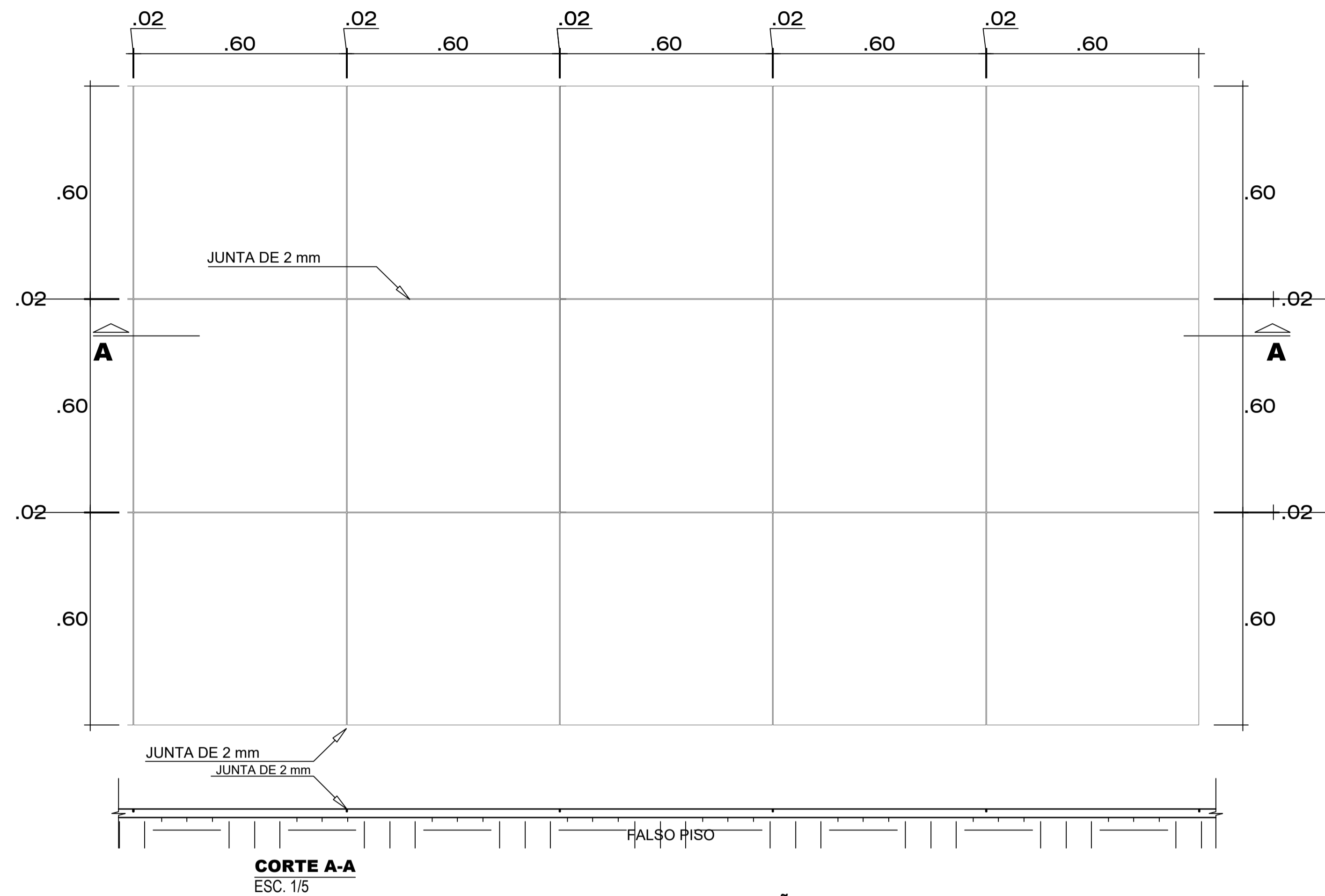

DETALLE DE PISO EN BAÑOS
ESC. 1/10

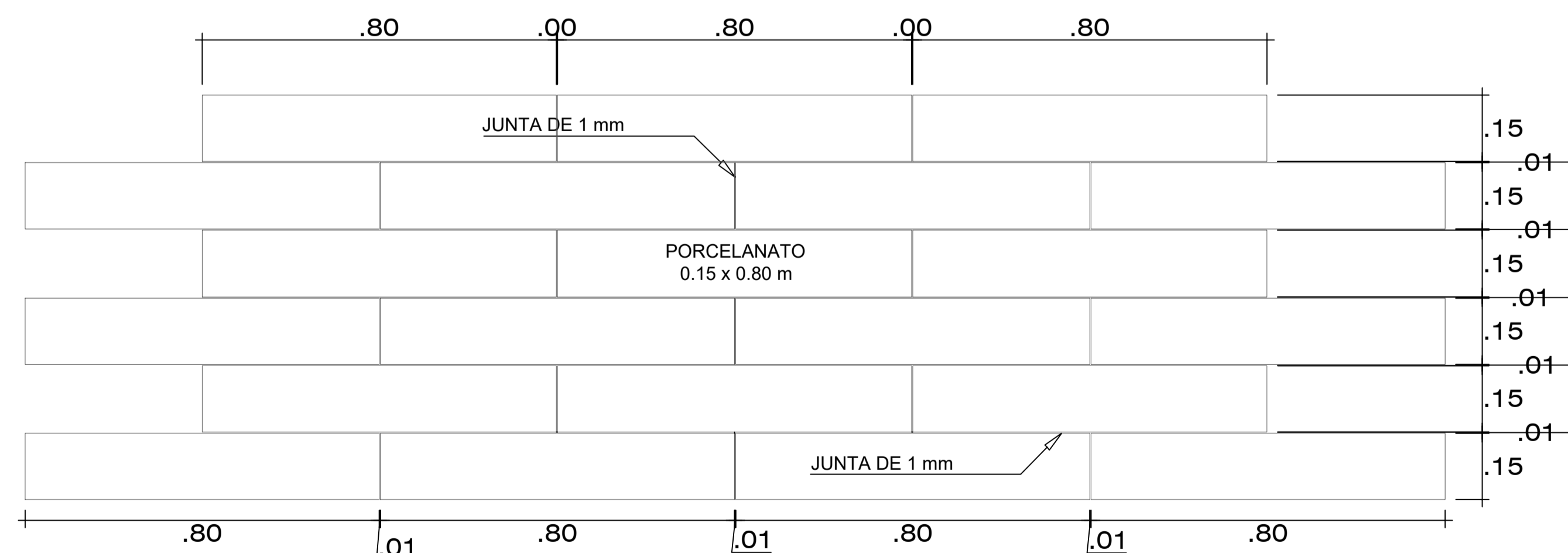

DETALLE DE PISO PORCELANATO MADERADO CLARO
ESC. 1/10

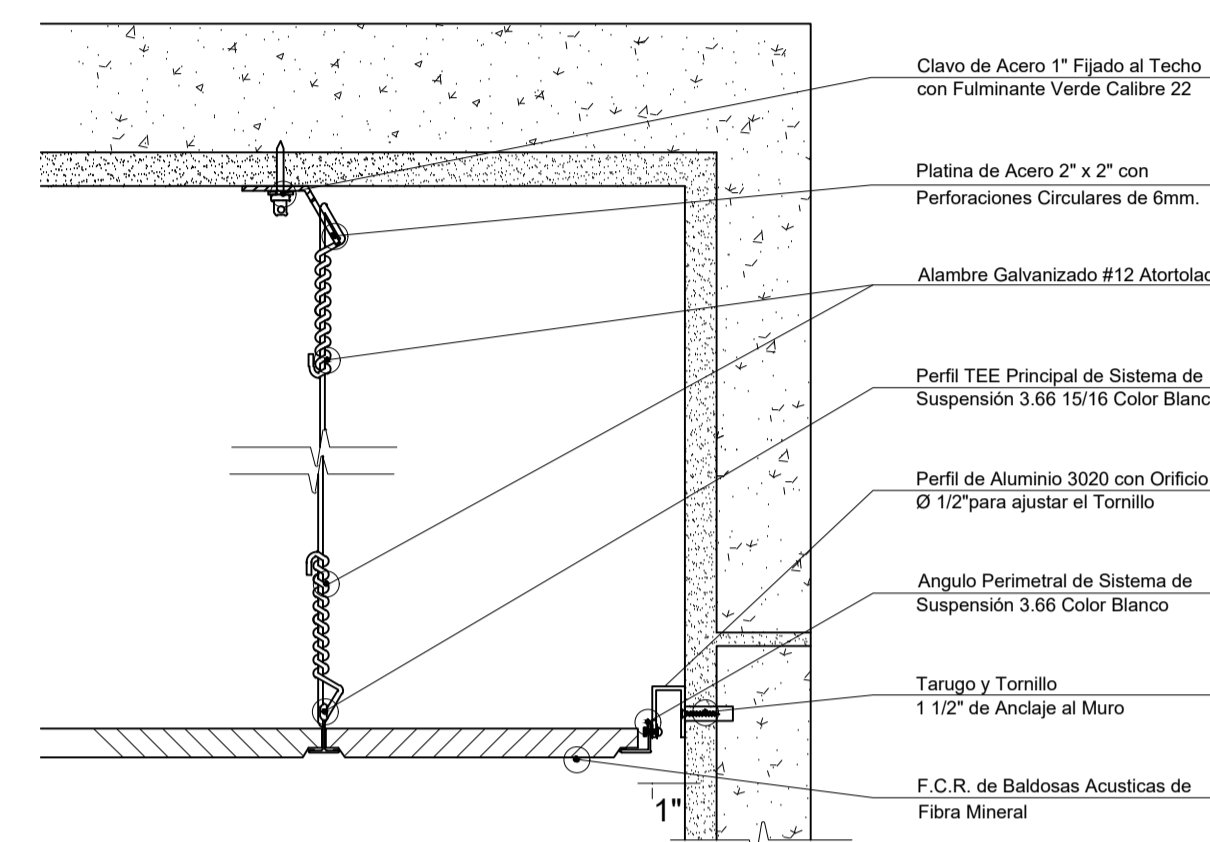

DETALLE - FALSO CIELO RASO
ESC. 1/10

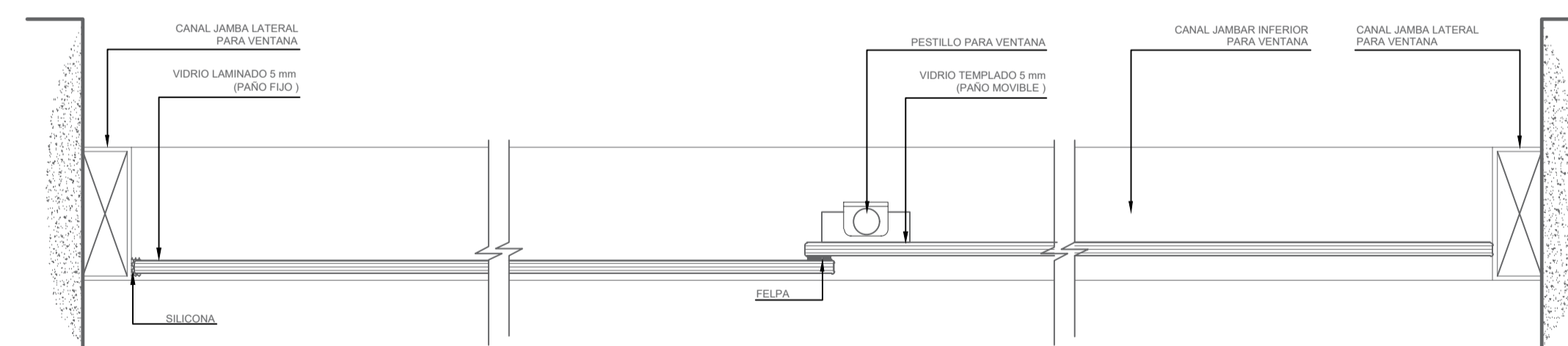

DETALLE VENTANA CORREDIZA
ESC. 1/2.5



UNIVERSIDAD PRIVADA DE TACNA
FACULTAD DE ARQUITECTURA Y URBANISMO

PROYECTO:	TERMINAL TERRESTRE			ESCALA:	1/25
PLANO:	PLANO PROYECTO - SECTOR 2 - PRIMER NIVEL			LAMINA:	DE-04
ASESOR:	BACHILLER:	UBICACIÓN:	LUGAR:	FECHA:	
ARQ. JANETH NOEMI CRUZ CHIRI	ALEXIS EDDY PONGO COPA	DISTRITO ALTO DE LA ALIANZA	TACNA - PERÚ	28/09/2020	
	CURSO:				
	VIII - TALLER TUTORIAL DE TESIS				

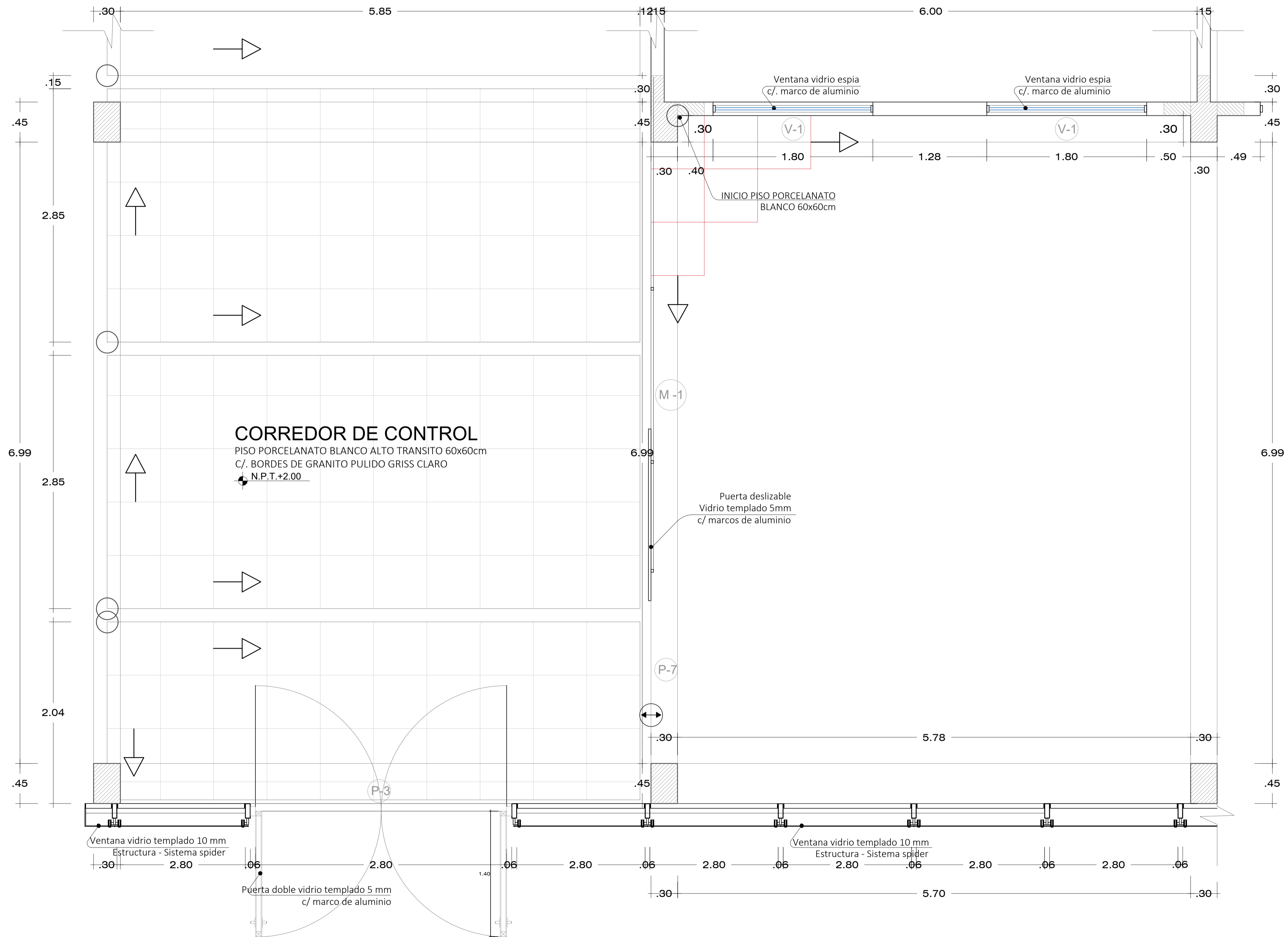

PLANO DE ZONA DE EMBARQUE

ESC. 1/25



UNIVERSIDAD PRIVADA DE TACNA FACULTAD DE ARQUITECTURA Y URBANISMO			
PROYECTO: TERMINAL TERRESTRE			
PLANO: PLANO DE DETALLES - SECTOR 2			ESCALA: 1/25
ASESOR: ARQ. JANETH NOEMI CRUZ CHIRI	BACHILLER: ALEXIS EDDY PONGO COPA	UBICACIÓN: DISTRITO ALTO DE LA ALIANZA	LAMINA: DE-05
CURSO: VIII - TALLER TUTORIAL DE TESIS		LUGAR: TACNA - PERÚ	FECHA: 28/09/2020

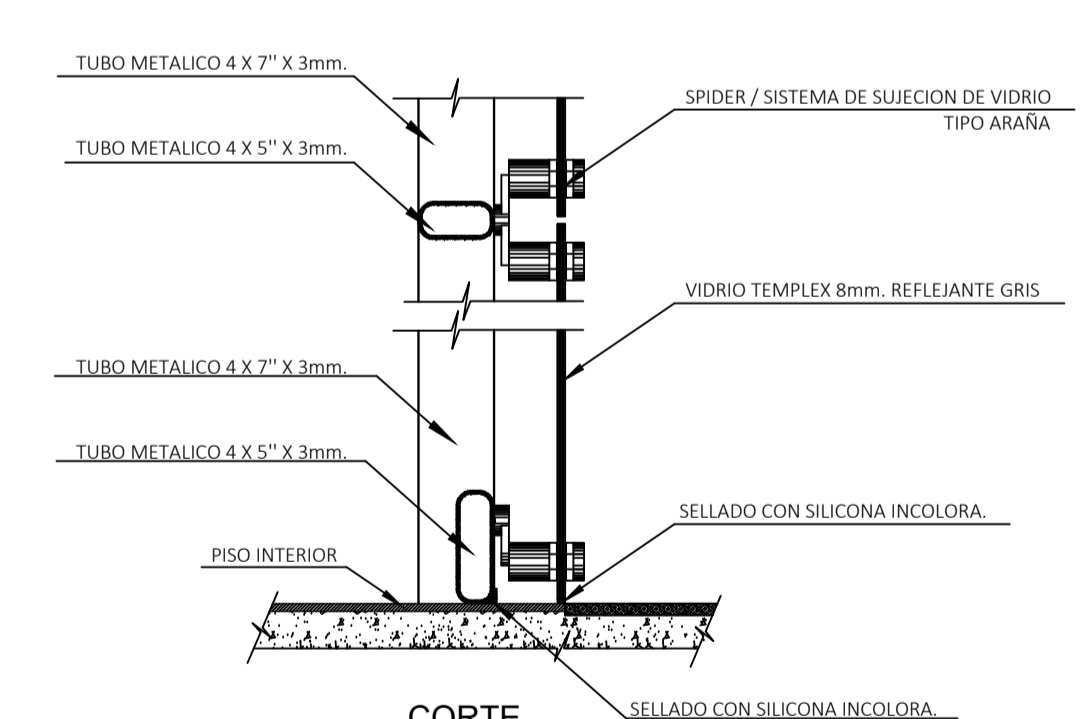
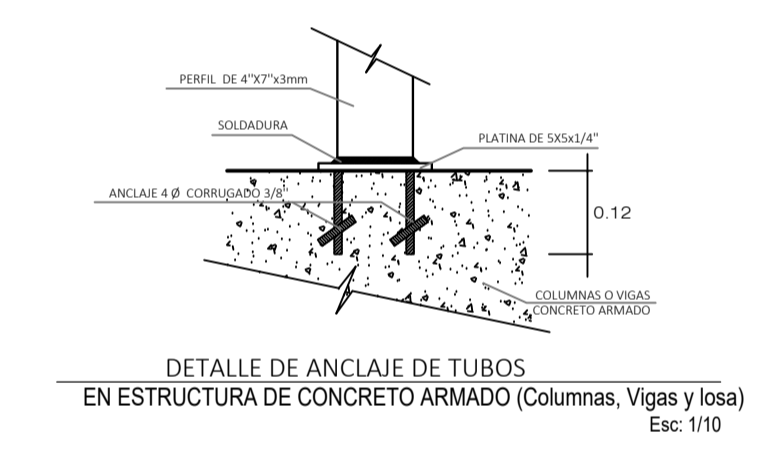
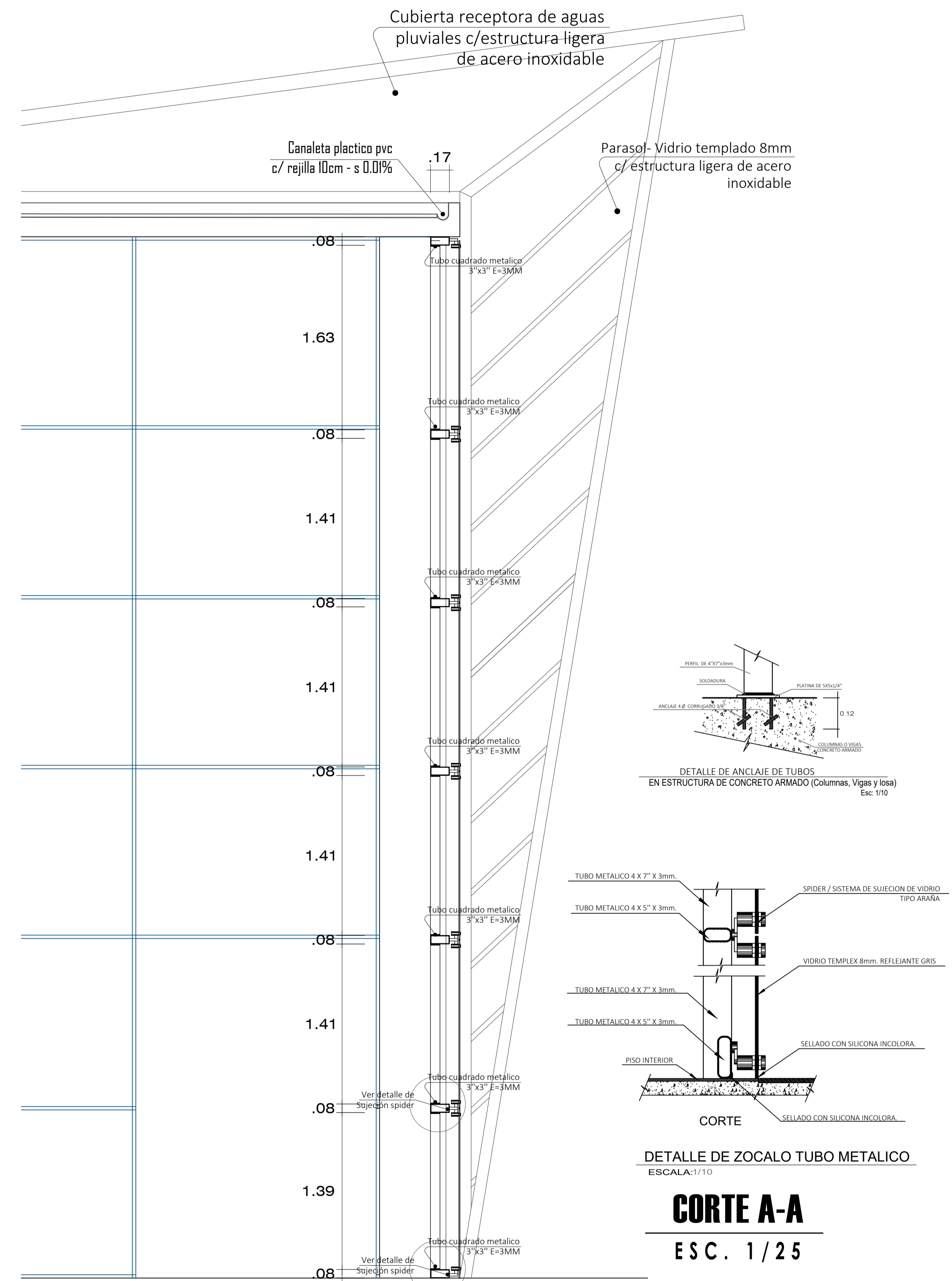
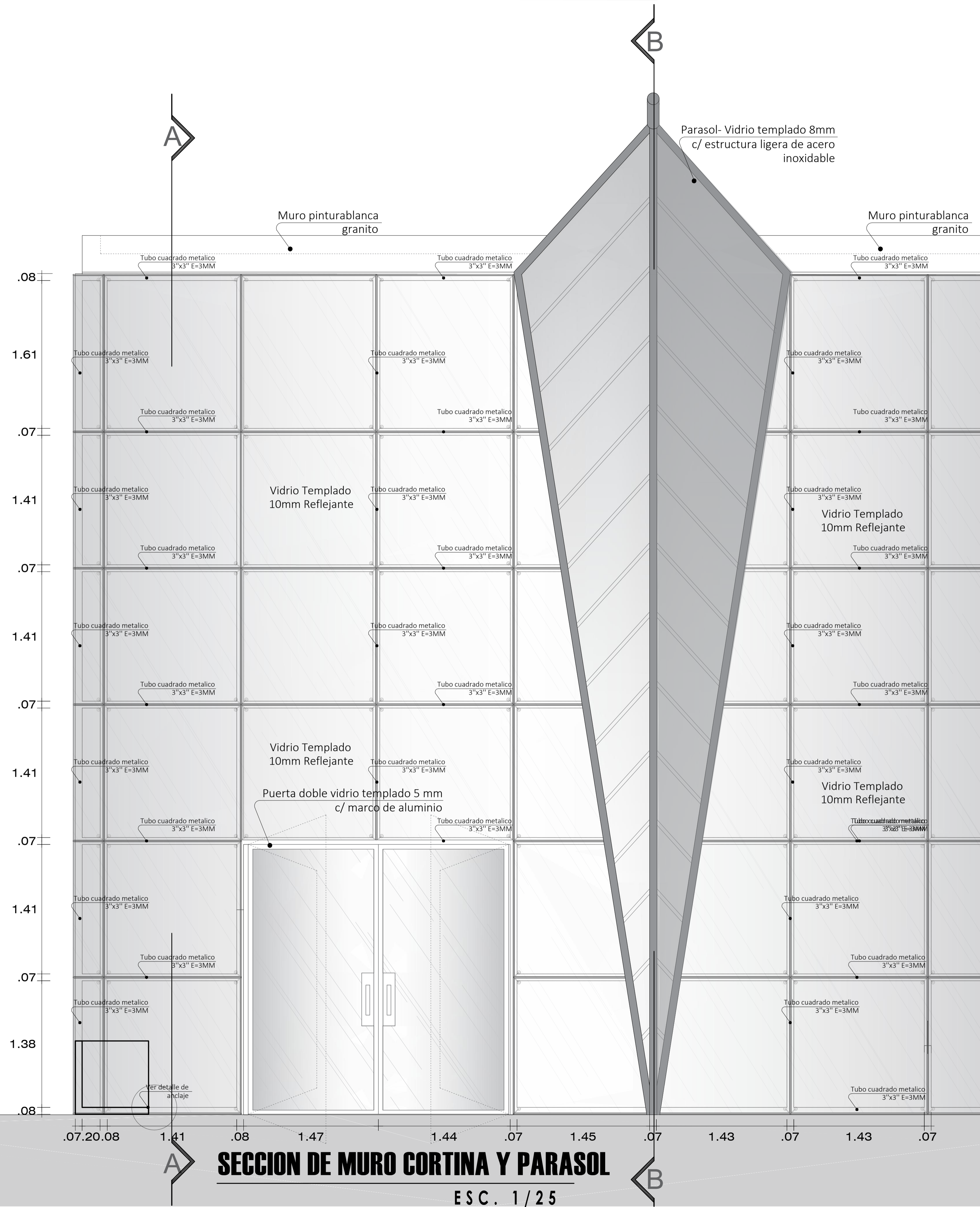

UNIVERSIDAD PRIVADA DE TACNA FACULTAD DE ARQUITECTURA Y URBANISMO			
PROYECTO:		TERMINAL TERRESTRE	
PLANO:		PLANO DE DETALLES - SECTOR 2	
ASESOR:	BACHILLER:	UBICACION:	LAMINA:
ARQ. JANETH NOEMI CRUZ CHIRI	ALEXIS EDDY PONGO COPA	DISTRITO ALTO DE LA ALIANZA	1/25
CURSO:	LUGAR:	FECHA:	DE-06
VIII - TALLER TUTORIAL DE TESIS	TACNA - PERÚ	28/09/2020	

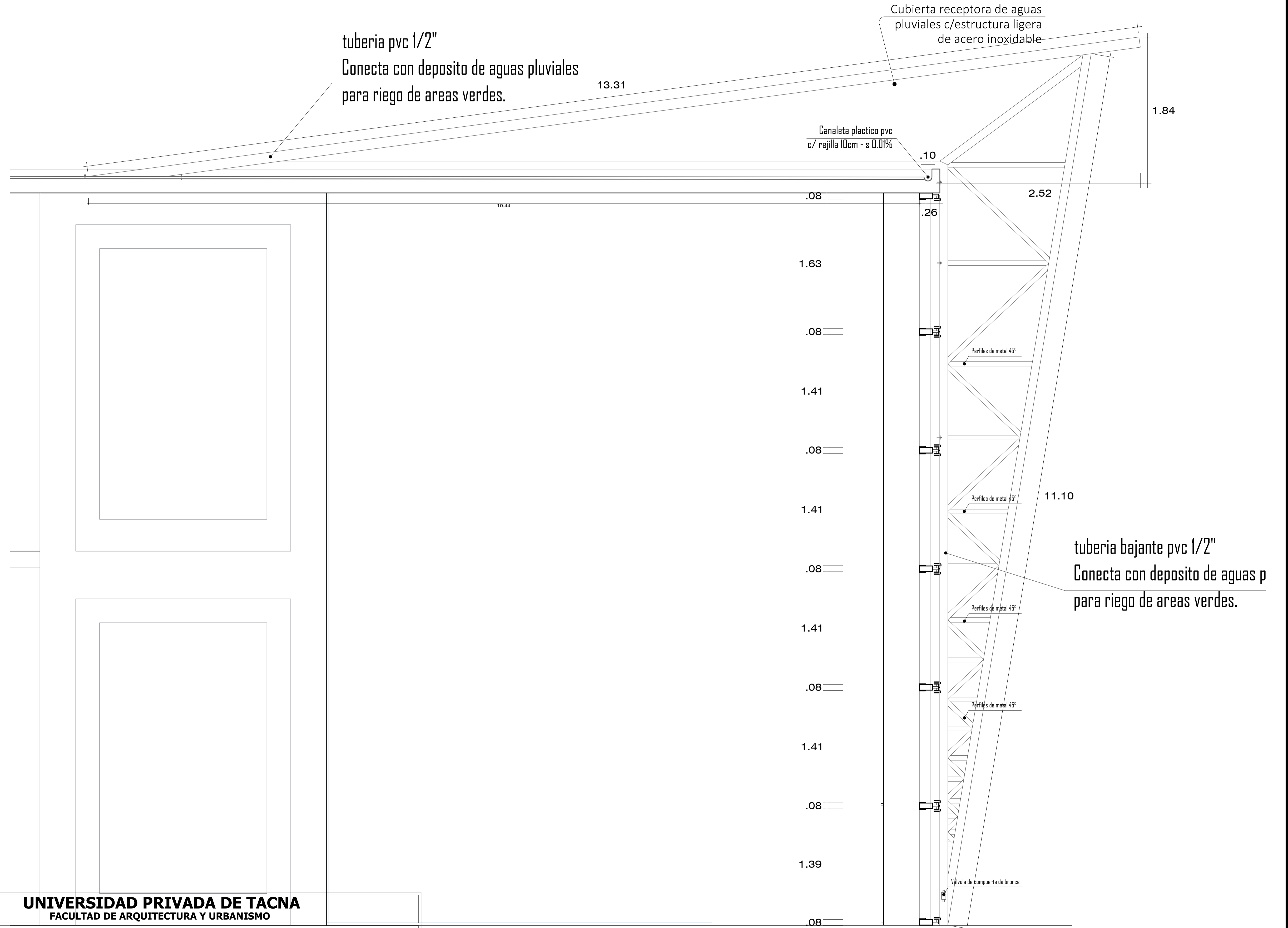

	UNIVERSIDAD PRIVADA DE TACNA		
	FACULTAD DE ARQUITECTURA Y URBANISMO		
	PROYECTO: TERMINAL TERRESTRE		
	PLANO: PLANO DE DETALLES - SECTOR 2		
ASESOR:	BACHILLER:	UBICACIÓN:	ESCALA:
ARQ. JANETH NOEMI CRUZ CHIRI	ALEXIS EDDY PONGO COPA	DISTRITO ALTO DE LA ALIANZA	1/25
CURSO:	LUGAR:	FECHA:	LAMINA:
VIII - TALLER TUTORIAL DE TESIS	TACNA - PERÚ	28/09/2020	DE-07

CORTE B-B
ESC. 1/25