

PRIMER NIVEL BLOQUE PABELLON
ESCALA 1/50

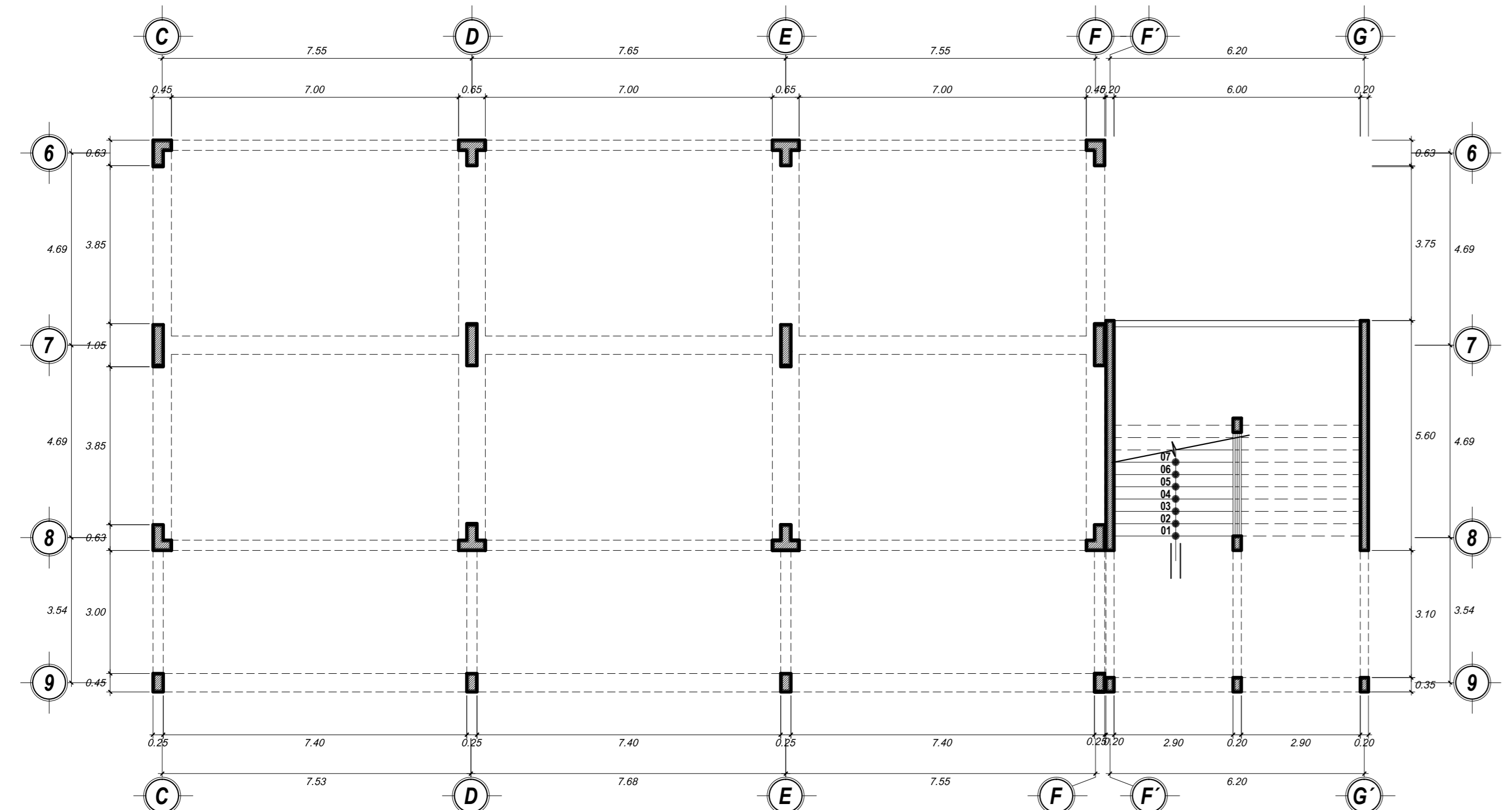

ESQUEMA ESTRUCTURAL PABELLON
ESCALA 1/100

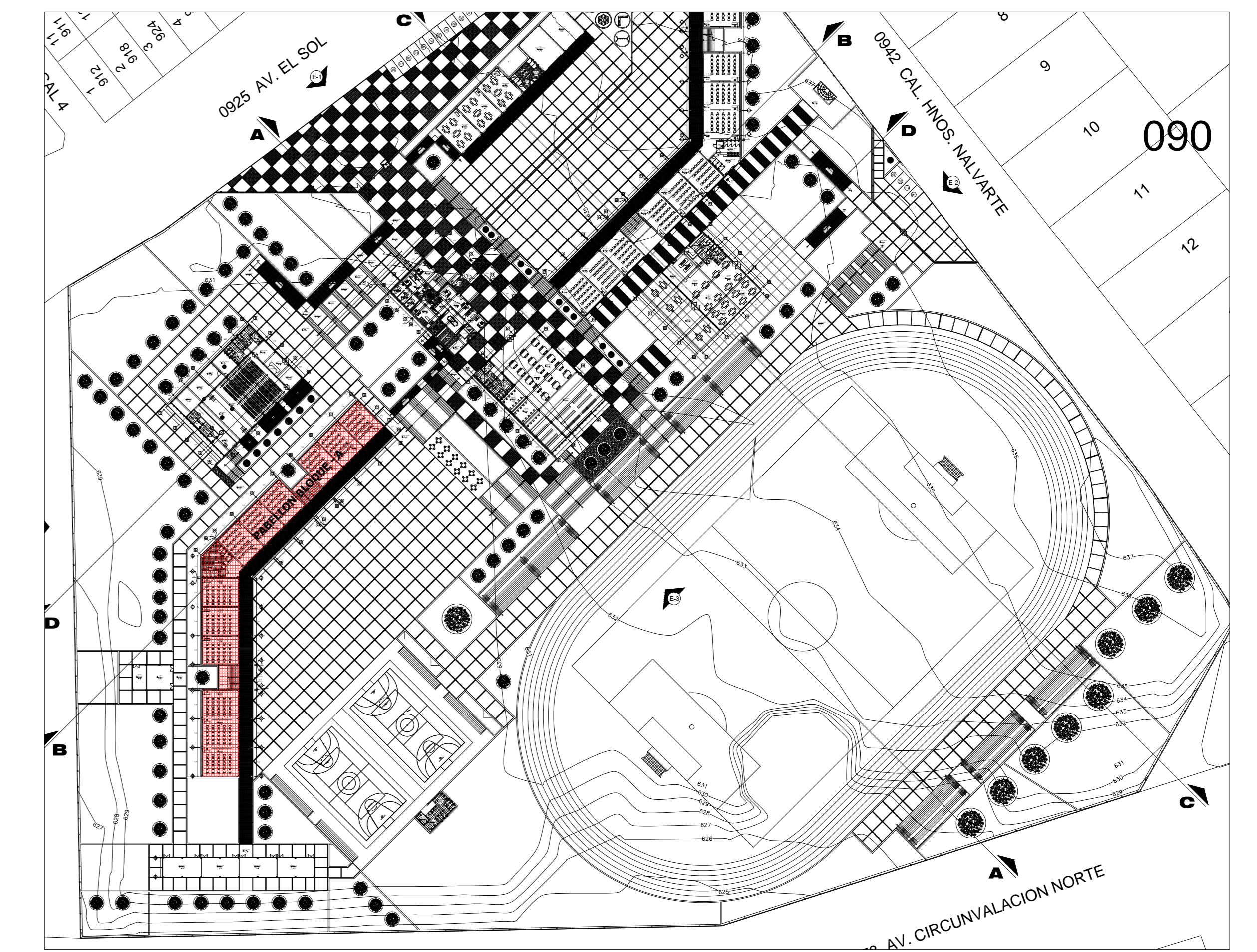

PLANO ANTEPROYECTO
ESCALA 1/1000

CUADRO DE ACABADOS

ACABADOS	MUIROS		CIELOS RASOS	PISOS	ZOCALOS	CUBIERTAS	CARPINTERIA DE MADERA	CARPINTERIA METALICA	VIDRIOS	MUIROS	PINTURA	APARATOS SANITARIOS		
	MURO DE BLOQUERIA	MURO DE ALBAÑILERIA	MURO DE ALBAÑILERIA	MAYOLICA	CEMENTO PULIDO	PORCELANATO	MUEBLES PUERTAS	MUEBLES PUERTAS	ALUMINIO	INCOLORO DE 6MM	LATEX ACRILICO	INODOOR	LAVATOR	URINAR
MURO DE BLOQUERIA														
MURO DE ALBAÑILERIA		●												
MAYOLICA				●										
CEMENTO PULIDO					●									
PORCELANATO						●								
MAYOLICA BLANCA														
LOSAS ALIGERADAS														
MUEBLES PUERTAS							●							
MUEBLES PUERTAS								●						
METALICA ENROLLABLE									●					
METALICA DE DOS HOJAS										●				
REJILLA DE FERRO														
FEERRO														
ALUMINIO														
CATERAL														
INCOLORO DE 6MM														
LATEX ACRILICO														
SUPERMATE														
LATEX ACRILICO														
CIELO MATE														
ALUMINIZ														
BASE ANTIDERRAMA														
TANQUE BAJO														
TANQUE ALTO														
DE LOSA														
DE CONCRETO ENCOCHADO														
REVESTIDOS														
REVESTIDOS														
APARATO DE LOSA														

AMBIENTES
AULA
PASADIZO
AULA SECUNDARIA
ESCALERA

CUADRO DE VANOS - PUERTAS

PUERTA	ANCHO	ALTO	DESCRIPCION	CANT.
P-01	1.10	2.10	Puerta de madera contraplacada	06

CUADRO DE VANOS - VENTANAS

PUERTA	ANCHO	ALTO	ALFEL	DESCRIPCION	CANT.
V-01	7.00	0.80	2.20	Ventana tipo sistema 6mm - detalle	03
V-02	4.80	0.80	2.20	Ventana tipo sistema 6mm - detalle	03
V-03	6.00	0.80	2.20	Ventana tipo sistema 6mm - detalle	01

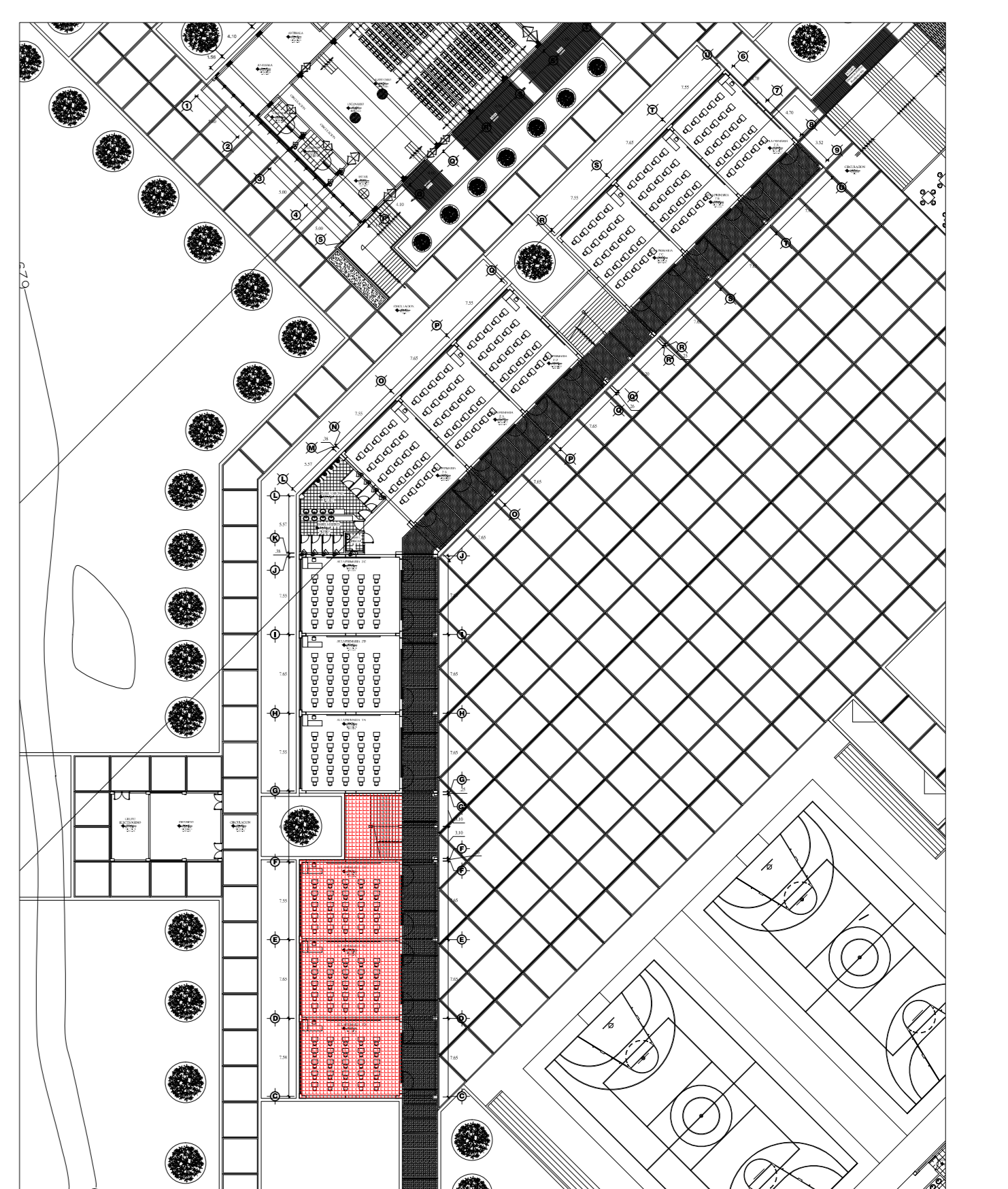

BLOQUE PABELLON A
ESCALA 1/500

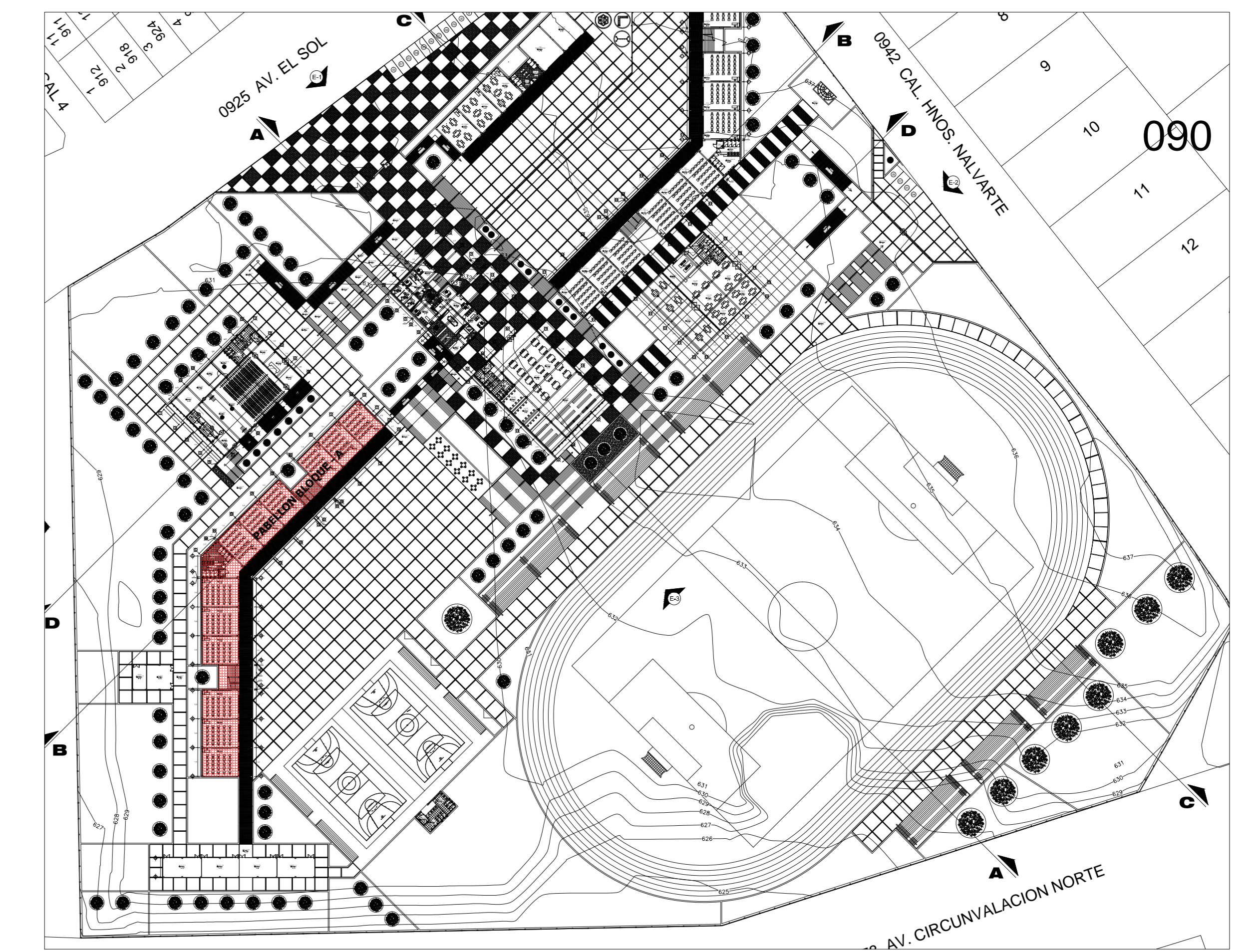
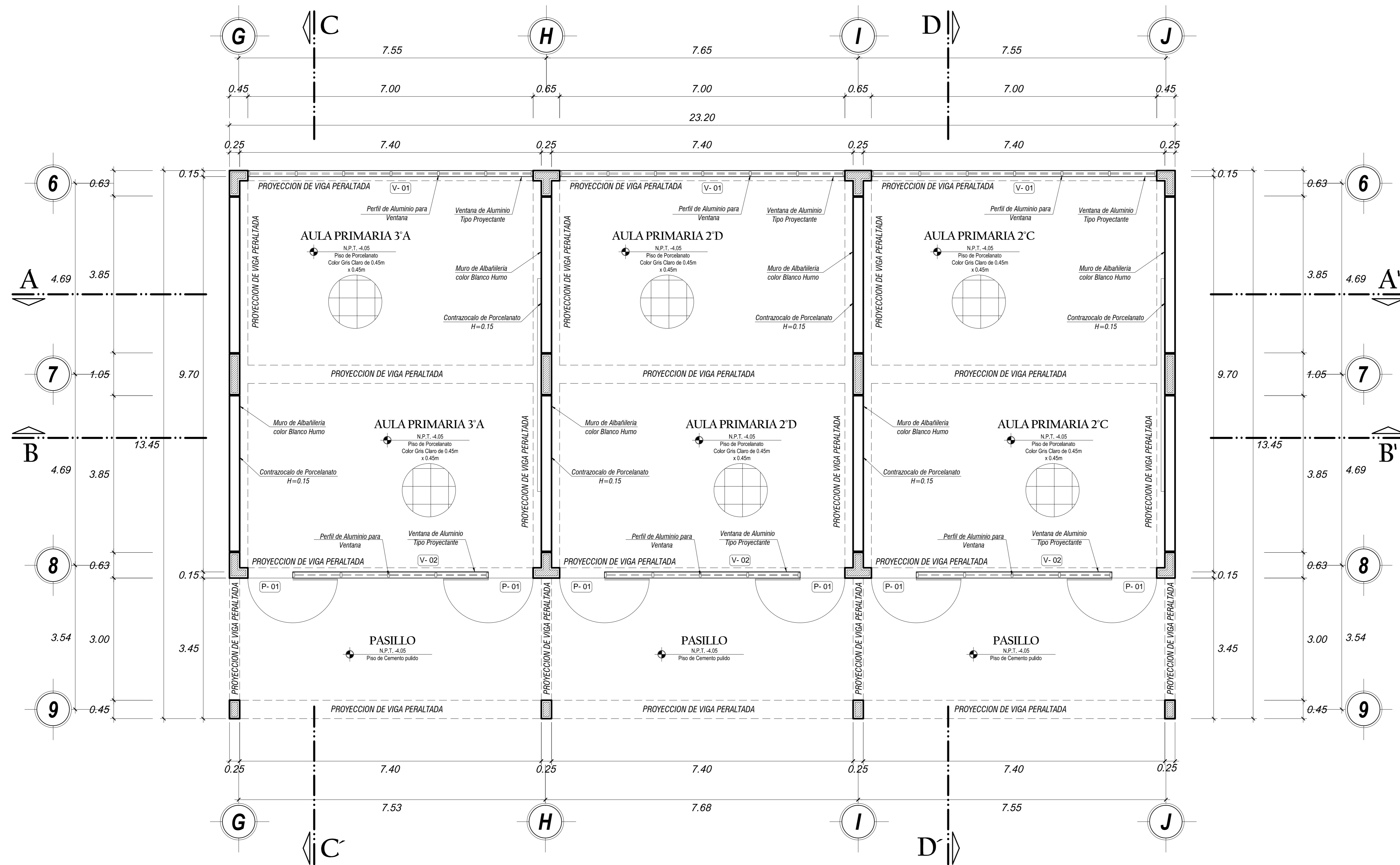
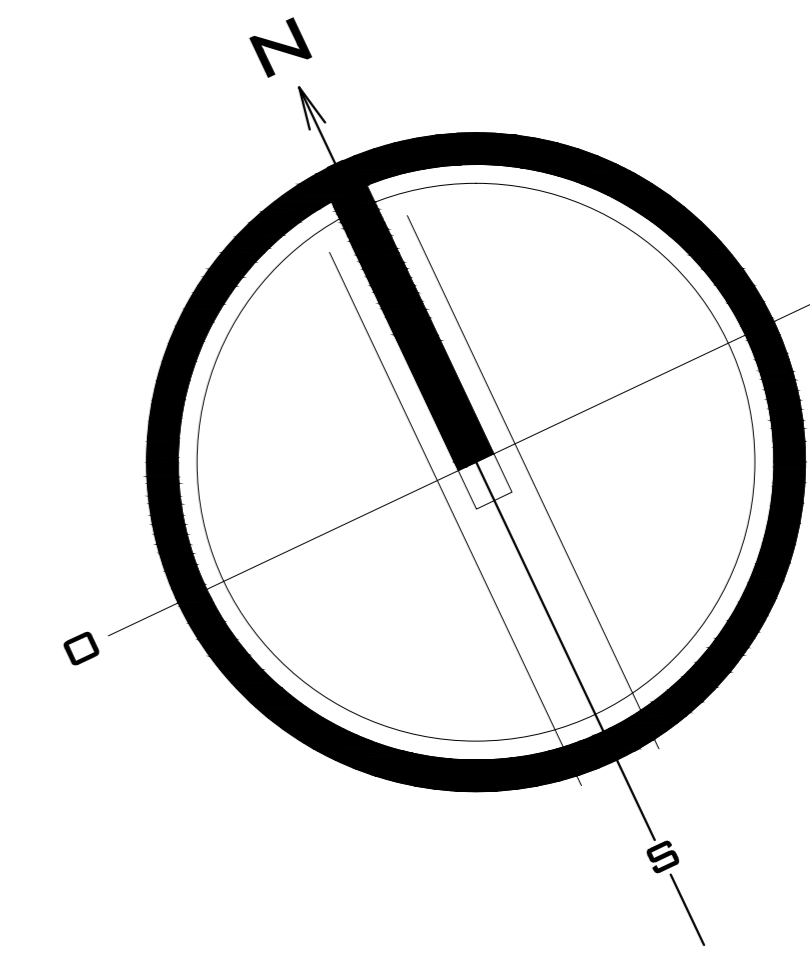

PLANO ANTEPROYECTO
ESCALA 1/1000

SEGUNDO NIVEL BLOQUE PABELLON
ESCALA 1/50

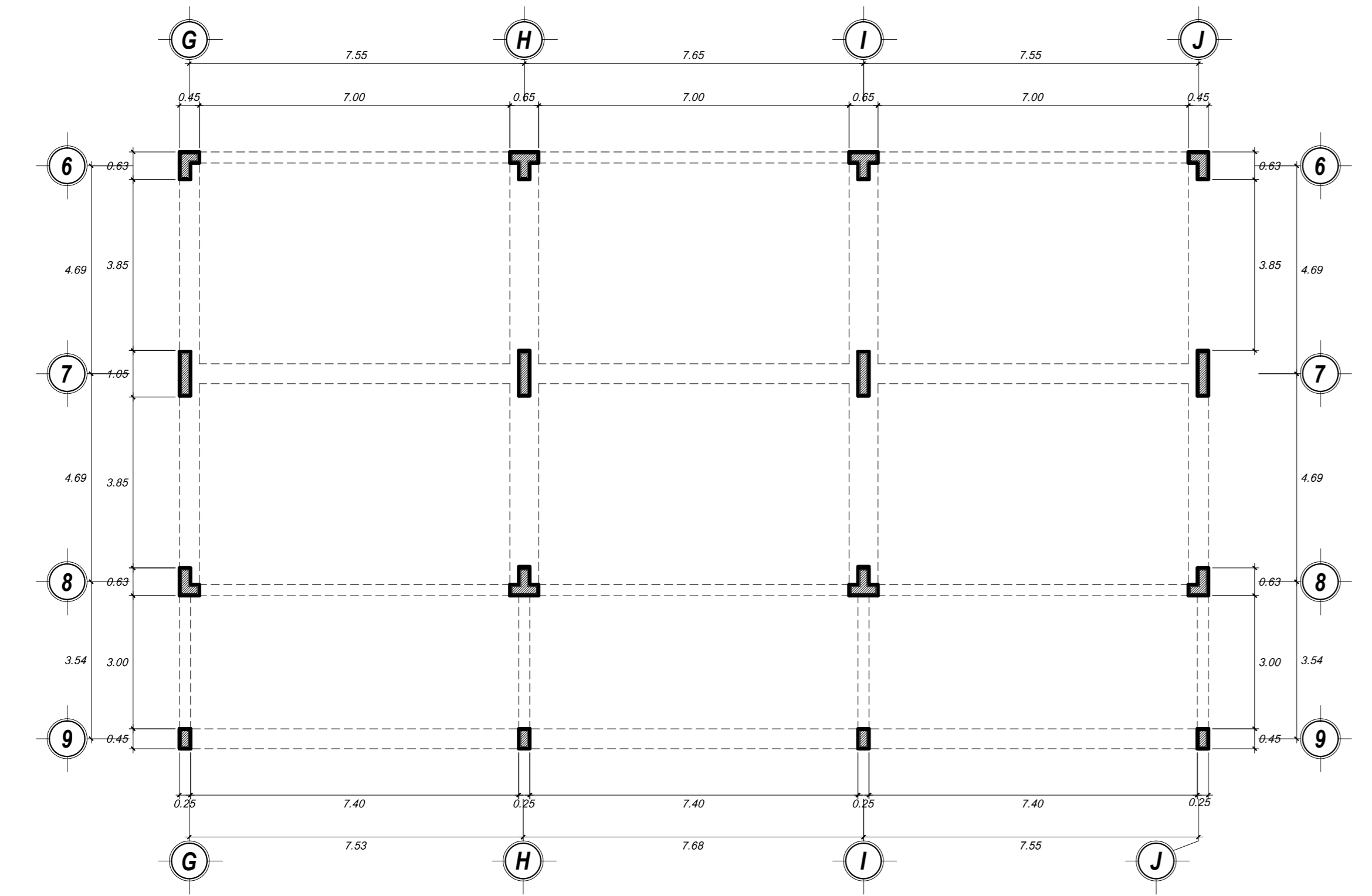

ESQUEMA ESTRUCTURAL PABELLON
ESCALA 1/100

CUADRO DE ACABADOS

ACABADOS	MUROS	CIelos RASOS	PISOS	ZOCALOS	CUBIERTAS	CARPINTERIA DE MADERA	CARPINTERIA METALICA	VIDRIOS	PINTURA	APARATOS SANITARIOS
AMBIENTES	MUROS	CIelos RASOS	PISOS	ZOCALOS	CUBIERTAS	CARPINTERIA DE MADERA	CARPINTERIA METALICA	VIDRIOS	PINTURA	APARATOS SANITARIOS
AULA	•	•	•	•	•	•	•	•	•	•
PASADIZO	•	•	•	•	•	•	•	•	•	•
AULA SECUNDARIA	•	•	•	•	•	•	•	•	•	•

CUADRO DE VANOS - PUERTAS

PUERTA	ANCHO	ALTO	DESCRIPCION	CANT.
P-01	1.10	2.10	Puerta de madera contralaminada	08

CUADRO DE VANOS - VENTANAS

PUERTA	ANCHO	ALTO	ALFEI	DESCRIPCION	CANT.
V-01	7.00	0.90	2.20	Ventana tipo sistema 6mm - detalle	03
V-02	4.80	0.80	2.20	Ventana tipo sistema 6mm - detalle	03



BLOQUE PABELLON A
ESCALA 1/500

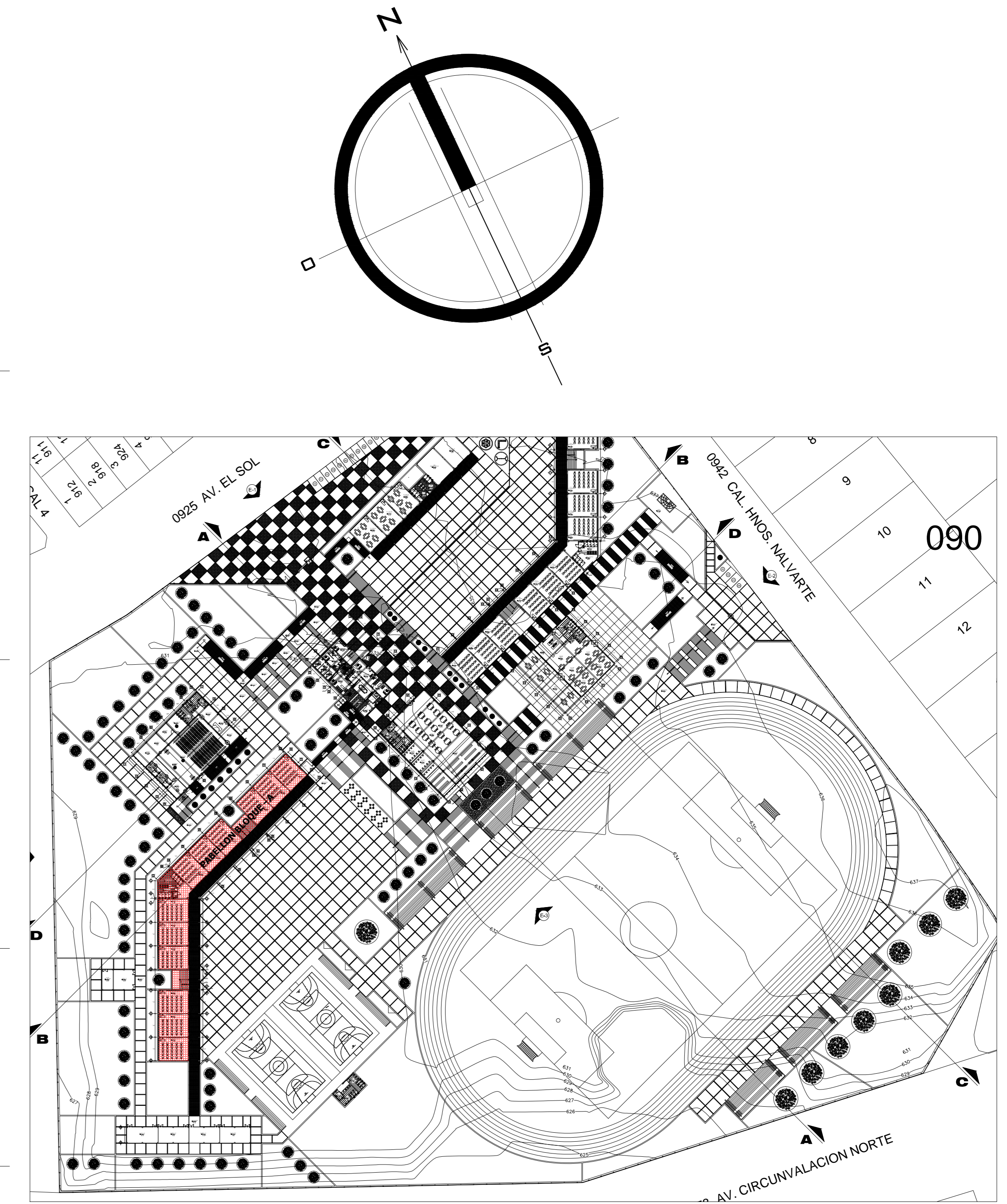
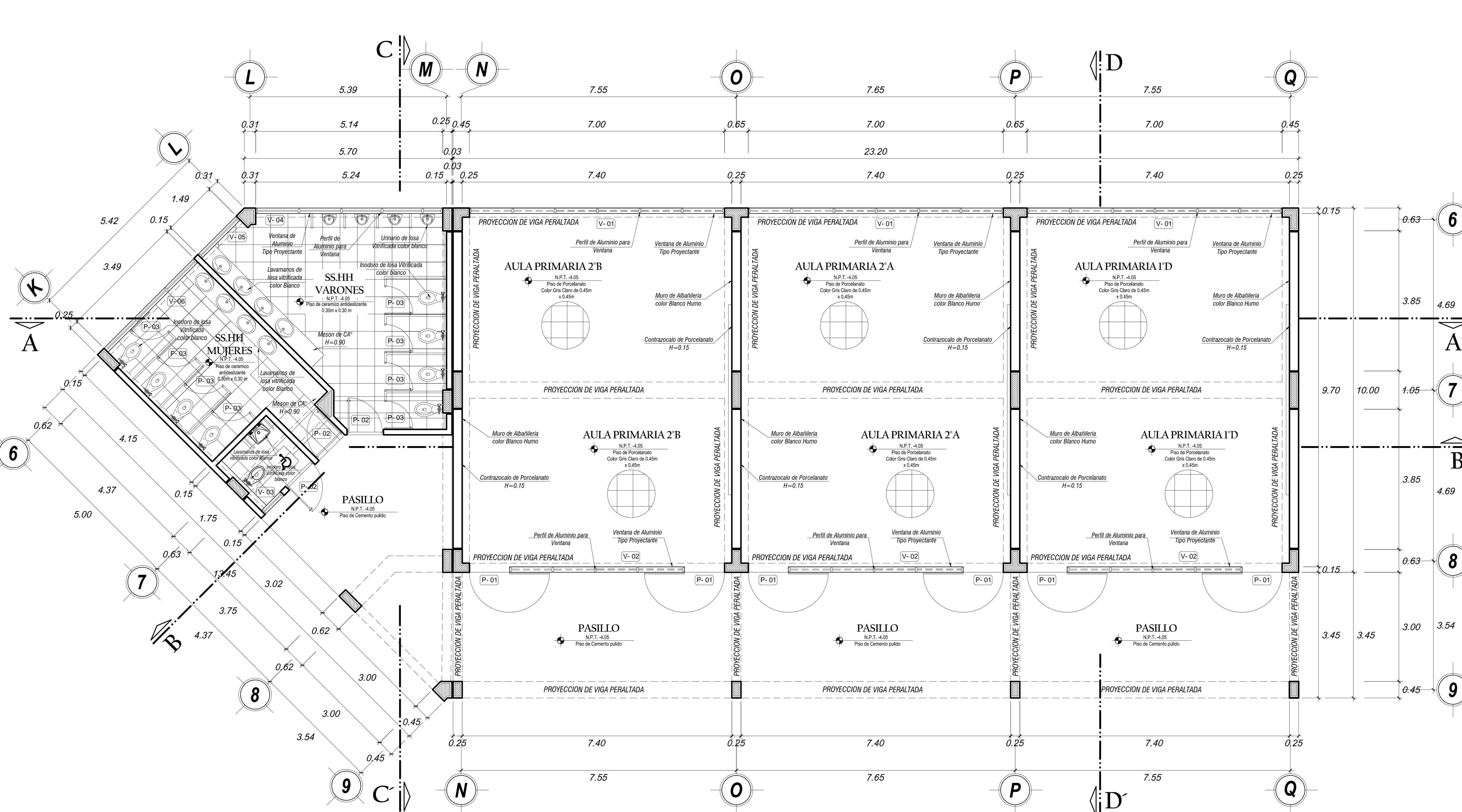

PLANO ANTEPROYECTO
ESCALA 1/1000

TERCER NIVEL BLOQUE PABELLON
ESCALA 1/50

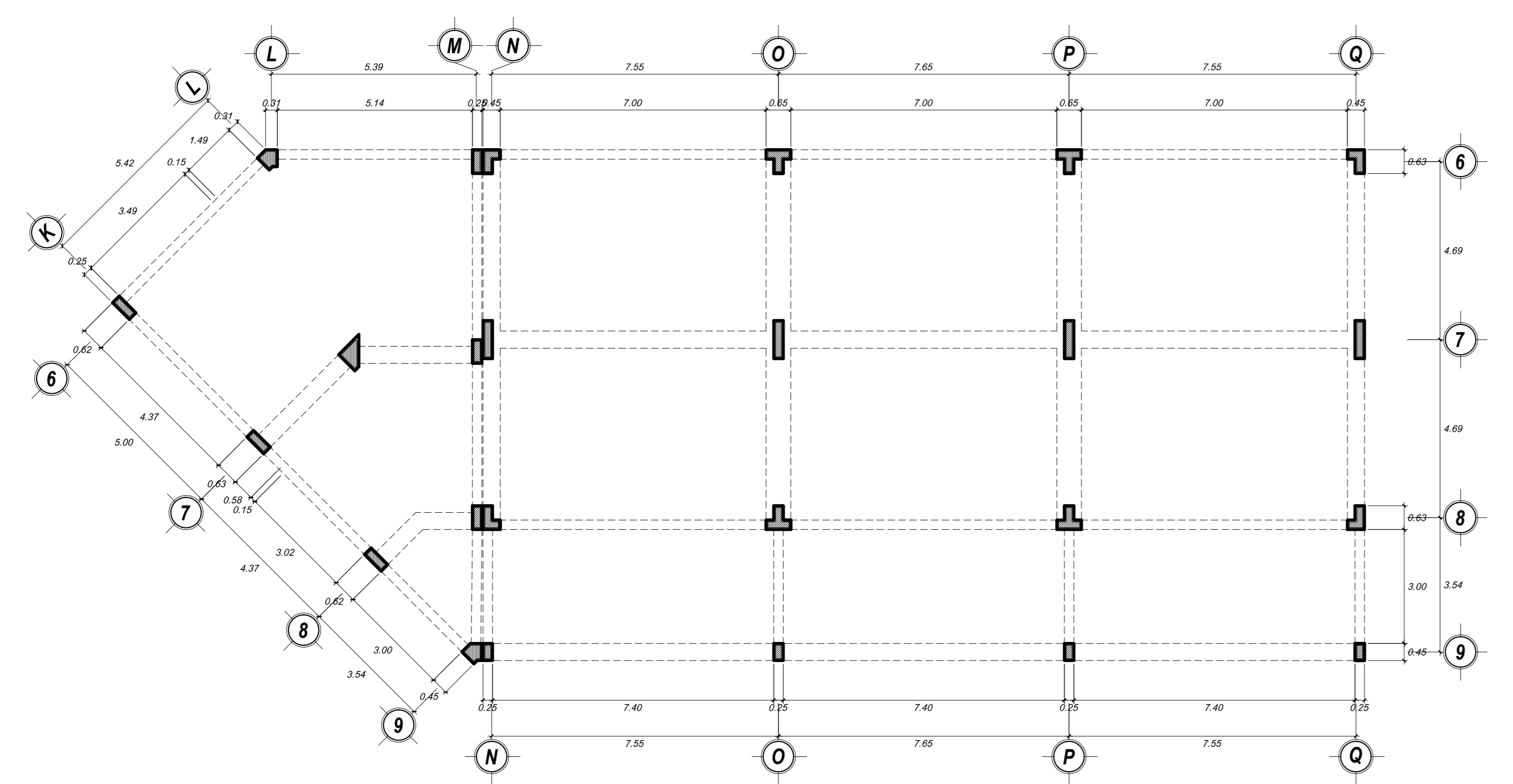

ESQUEMA ESTRUCTURAL PABELLON
ESCALA 1/100

CUADRO DE ACABADOS

ACABADOS	MUIROS		CEILOS RASOS	PISOS	ZOCALOS	CUBIERTAS	CARPINTERIA DE MADERA	CARPINTERIA METALICA	VIDRIOS	PINTURA	APARATOS SANITARIOS
	MURO DE BLOQUETA	TABICAJERIA DE MADERA	BALDOSA LINEAL	CERAMICO ANTEDEBLIZANTE	POZOLANATO	MAYOLICA BLANCA	PUERTAS	PUERTAS	MURO	C. RASO	INODOR
AULA	•	•	•	•	•	•	•	•	•	•	•
PASADIZO	•	•	•	•	•	•	•	•	•	•	•
AULA SECUNDARIA	•	•	•	•	•	•	•	•	•	•	•
SS-HH VARONES	•	•	•	•	•	•	•	•	•	•	•
SS-HH MUJERES	•	•	•	•	•	•	•	•	•	•	•
SS-HH DISCAPACITADOS	•	•	•	•	•	•	•	•	•	•	•

CUADRO DE VANOS - PUERTAS

PUERTA	ANCHO	ALTO	DESCRIPCION	CANT.
P-01	1.10	2.10	Puerta de madera contrapunteada	01
P-02	1.00	2.10	Puerta de madera contrapunteada	01
P-03	0.80	1.80	Puerta de madera contrapunteada	01

CUADRO DE VANOS - VENTANAS

VENTANA	ANCHO	ALTO	DESCRIPCION	CANT.
V-01	2.20	0.80	Ventana tipo sistema 6mm - 6alabe	03
V-02	4.80	0.80	Ventana tipo sistema 6mm - 6alabe	03
V-03	0.74	0.80	Ventana tipo sistema 6mm - 6alabe	01
V-04	5.14	0.80	Ventana tipo sistema 6mm - 6alabe	01
V-05	1.40	0.80	Ventana tipo sistema 6mm - 6alabe	01
V-06	3.40	0.80	Ventana tipo sistema 6mm - 6alabe	01

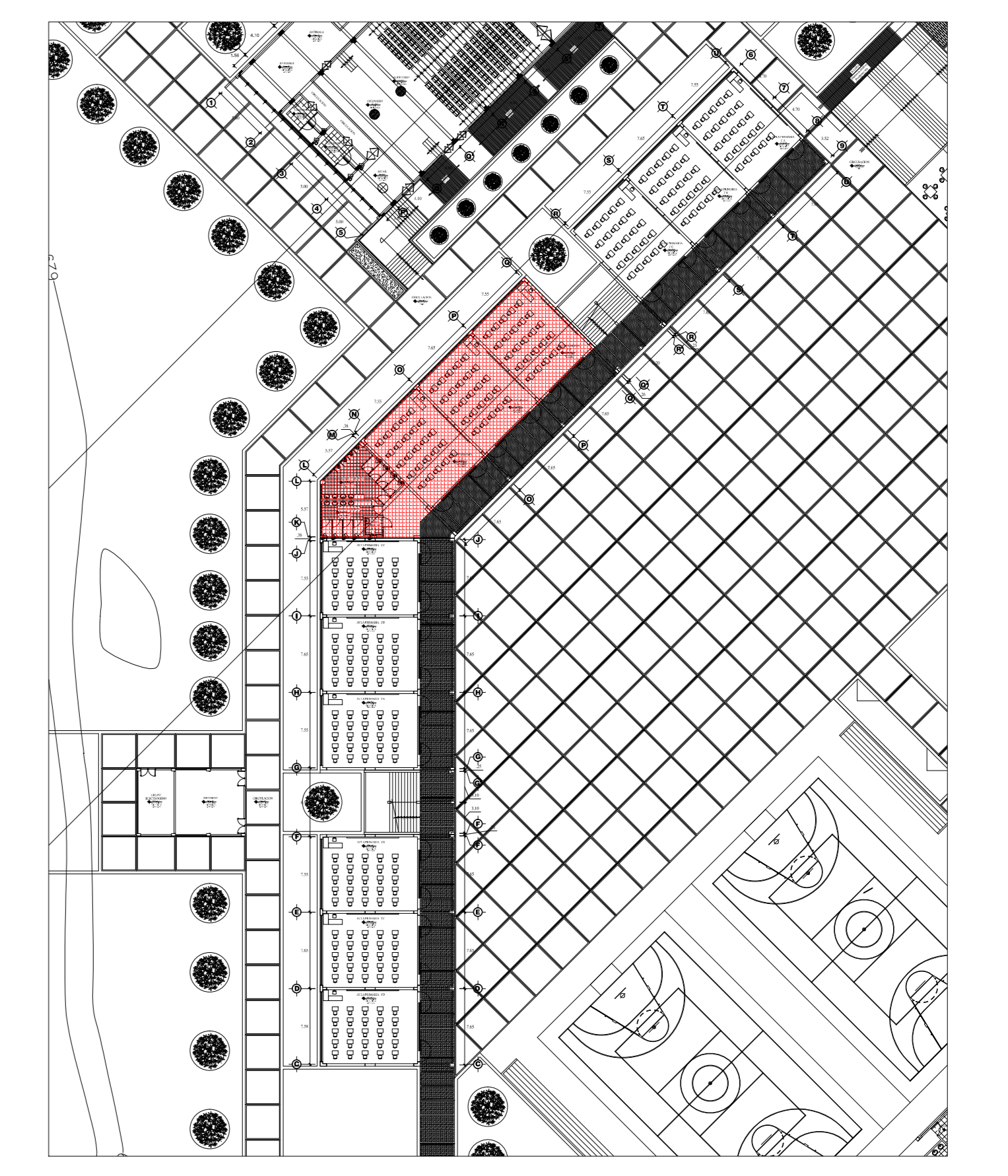

BLOQUE PABELLON A
ESCALA 1/500